



INVERTER

Option unit

FR-PU04

FR-PU04V

INSTRUCTION MANUAL

Parameter unit



PRE-OPERATION
INSTRUCTIONS

1

FUNCTIONS

2

HELP

3

OPERATION

4

CHECK FIRST WHEN YOU
HAVE A TROUBLE

5

SPECIFICATIONS

6

Thank you for choosing the Mitsubishi inverter option unit. This instruction manual gives handling information and precautions for use of this equipment. Incorrect handling might cause an unexpected fault. Before using the equipment, please read this manual carefully to use the equipment to its optimum. Please forward this manual to the end user.

This section is specifically about safety matters

Do not attempt to install, operate, maintain or inspect this product until you have read through this instruction manual and appended documents carefully and can use the equipment correctly. Do not use this product until you have a full knowledge of the equipment, safety information and instructions. In this instruction manual, the safety instruction levels are classified into "WARNING" and "CAUTION".

WARNING

Assumes that incorrect handling may cause hazardous conditions, resulting in death or severe injury.

CAUTION

Assumes that incorrect handling may cause hazardous conditions, resulting in medium or slight injury, or may cause physical damage only.

Note that the  CAUTION level may lead to a serious consequence according to conditions. Please follow the instructions of both levels because they are important to personnel safety.

SAFETY INSTRUCTIONS

1. Electric Shock Prevention

WARNING

- While the inverter power is ON, do not open the front cover. Do not run the inverter with the front cover removed. Otherwise you may access the exposed high voltage terminals or the charging part of the circuitry and get an electric shock.
- Before starting wiring or inspection, check that the operation panel indicator is OFF, wait for at least 10 minutes after the power supply has been switched OFF, and check that there are no residual voltage using a tester or the like. The capacitor is charged with high voltage for some time after power OFF and it is dangerous.
- Any person who is involved in the wiring or inspection of this equipment should be fully competent to do the work.
- Always install the inverter before wiring. Otherwise, you may get an electric shock or be injured.
- Operate the keys with dry hands to prevent an electric shock.

2. Additional Instructions

To prevent injury, damage or product failure, please note the following points.

(1) Transportation and mounting

CAUTION

- Do not install and operate the parameter unit (FR-PU04/PU04V) if it is damaged or has parts missing.
- Do not stand or rest heavy objects on this equipment.
- Check the inverter mounting orientation is correct.
- The parameter unit (FR-PU04/PU04V) is a precision device. Do not drop it or subject it to impact.
- Use the inverter under the following environmental conditions:

Environment	Surrounding air temperature	-10°C to +50°C (non-freezing)
	Ambient humidity	90%RH or less (non-condensing)
	Storage temperature	-20°C to +65°C*
	Ambience	Indoors (free from corrosive gas, flammable gas, oil mist, dust and dirt)
	Altitude, vibration	Maximum 1000m above seal level, 5.9m/s ² or less at 10 to 55Hz (directions of X, Y, Z axes)

*Temperatures applicable for a short time, e.g. in transit.

- If halogen-based materials (fluorine, chlorine, bromine, iodine, etc.) infiltrate into a Mitsubishi product, the product will be damaged. Halogen-based materials are often included in fumigant, which is used to sterilize or disinfect wooden packages. When packaging, prevent residual fumigant components from being infiltrated into Mitsubishi products, or use an alternative sterilization or disinfection method (heat disinfection, etc.) for packaging. Sterilization or disinfection of wooden package should also be performed before packaging the product.

(2) Test operation and adjustment

CAUTION

- Before starting operation, confirm and adjust the parameters. A failure to do so may cause some machines to make unexpected motions.

(3) Usage

WARNING

- Since pressing  key may not stop output depending on the function setting status, provide a circuit and switch separately to make an emergency stop (power OFF, mechanical brake operation for emergency stop, etc).
- Make sure that the start signal is off before resetting the inverter alarm. A failure to do so may restart the motor suddenly.
- Do not modify the equipment.
- Do not perform parts removal which is not instructed in this manual. Doing so may lead to fault or damage of the inverter.

CAUTION

- When parameter clear or all parameter clear is performed, each parameter returns to the factory setting. Re-set the required parameters before starting operation.

(4) Corrective actions for alarm

CAUTION

- Provide safety backup devices, such as an emergency brake, to protect machines and equipment from hazard if the parameter unit (FR-PU04/PU04V) becomes faulty.

(5) Disposal

 **CAUTION**

- Treat as industrial waste.

(6) General instruction

All illustrations given in this manual may have been drawn with covers or safety guards removed to provide in-depth description. Before starting operation of the product, always return the covers and guards into original positions as specified and operate the equipment in accordance with the manual.

— CONTENTS —

INTRODUCTION	1
<hr/> <hr/>	
1 PRE-OPERATION INSTRUCTIONS	3
<hr/> <hr/>	
1.1 Unpacking and Product Confirmation	3
1.1.1 Unpacking confirmation	3
1.1.2 Appearance and parts identification	4
1.1.3 Explanation of keys	5
1.2 Installation and Removal of FR-PU04/PU04V	7
1.2.1 Direct installation to the inverter	7
1.2.2 Removal from the inverter	8
1.2.3 Installation using the connection cable (FR-CB2)	9
1.2.4 Removal when the connection cable (FR-CB2) is used	10
1.3 Parameters to be Checked First	11
1.3.1 PU display language selection (Pr. 145)	11
1.3.2 PU buzzer control (Pr. 990)	12
1.3.3 PU contrast adjustment (Pr. 991)	12
2 FUNCTIONS	13
<hr/> <hr/>	
2.1 Monitoring Function	13
2.1.1 Display overview	13
2.1.2 Using "SHIFT" to change the main monitor	15

2.1.3	Setting the power-ON monitor (the first priority monitor)	16
2.1.4	Using "READ" to change the main monitor	17
2.1.5	Using the parameter to change the monitor (Pr. 52)	18
2.2	Frequency Setting.....	20
2.2.1	Direct setting.....	20
2.2.2	Step setting.....	21
2.2.3	Precautions for frequency setting	22
2.3	Setting and Changing the Parameter Values	23
2.3.1	Specifying the parameter number to change the set value	23
2.3.2	Selecting the parameter from functional list to change the set value	24
2.3.3	Selecting the parameter from parameter list to change the set value	26
2.3.4	Selecting the parameter from User List to change the set value	27
2.3.5	Precautions for setting write	28
2.4	User Group Function	29
2.4.1	Registering the parameters to user group	30
2.4.2	Deleting the parameters from user group	31
2.4.3	Confirming the parameters registered to user group	31
2.5	Calibration of the Meter (Frequency Meter).....	32
2.5.1	Calibration of the FM terminal	32
2.5.2	Calibration of the AM terminal	33
2.6	Adjustment of the Frequency Setting Signals "Bias" and "Gain"	36
2.6.1	Adjustment procedure	36
3	HELP	42

3.1 Overview of the Help Menu	42
3.1.1 Help menu	42
3.1.2 Help menu transition.....	44
3.2 Operation Procedures for the Help Menu.....	48
3.2.1 Monitor function	48
3.2.2 Selection of PU operation (direct input).....	49
3.2.3 Selection of the PU Jog operation mode	50
3.2.4 Parameters	51
3.2.5 Parameter clear	54
3.2.6 Alarm history.....	56
3.2.7 Alarm clear	57
3.2.8 Inverter reset	58
3.2.9 Troubleshooting.....	59
3.2.10 Terminal assignment (Selectop).....	63
3.2.11 Option	64
3.2.12 Multiple copies.....	65
3.3 Other Precautions	70
3.3.1 Precautions for parameter unit operation	70

4 OPERATION 71

4.1 How to Select the Operation Mode.....	71
4.1.1 Switching from External operation mode [EXT] to PU operation mode [PU].....	71
4.1.2 Switching from PU operation mode [PU] to External operation mode [EXT].....	71
4.1.3 Switching to the External / PU combined operation mode	72

4.2	How to Operate PU Operation	74
4.2.1	Normal operation	74
4.2.2	PU Jog operation.....	75
4.3	Combined Operation (Operation Using External Input Signals and PU).....	76
4.3.1	Entering the start signal from outside and setting the running frequency from the PU (Pr. 79 = 3)	76
4.3.2	Entering the running frequency from outside and making start and stop from the PU (Pr. 79 = 4).....	77
4.3.3	Entering the start signal and multi-speed signal from outside and setting multiple speeds from the parameter unit.....	78
5	CHECK FIRST WHEN YOU HAVE A TROUBLE	79
5.1	Troubleshooting.....	79
6	SPECIFICATIONS	80
6.1	Standard Specifications	80
6.2	Outline Drawing and Panel Cutting Drawing.....	81
6.2.1	FR-PU04/PU04V outline dimension drawings.....	81
6.2.2	FR-PU04/PU04V enclosure cut dimensions.....	82
	APPENDIX	83
	Appendix 1 Disposing of the equipment in the EU countries	83



INTRODUCTION

This product is a unit for setting inverter functions (parameters) and has the following features.

- An operation panel can be removed and a parameter unit can be connected.
- Setting such as direct input method with a numeric keypad, operation status indication, and help function are usable.
- Eight languages can be displayed.
- Parameter setting values of maximum of three inverters can be stored.

This instruction manual uses the screens on the FR-PU04 connected to the FR-A500 series inverter for describing the operation.

For using the FR-PU04V, some indications or terms used in this instruction manual must be replaced as follows.

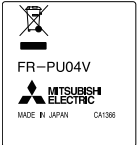
Item	FR-PU04	FR-PU04V
Name	Frequency, output frequency	Speed, running speed
Main monitor indication	60.00Hz	1500.0r
First monitor	Frequency	Speed
Monitor indication	F Command	S Command
Appearance		
Rating plate		
Terminal	FM	DA1
	AM	DA2

1 PRE-OPERATION INSTRUCTIONS

1.1 Unpacking and Product Confirmation

Take the parameter unit out of the package, check the unit name, and confirm that the product is as you ordered and intact.

1.1.1 Unpacking confirmation

Check the enclosed items.

- FR-PU04/PU04V

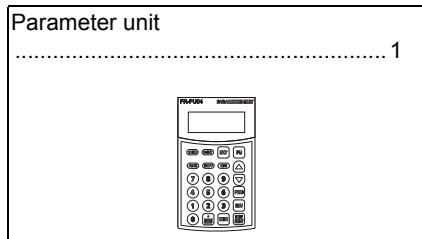





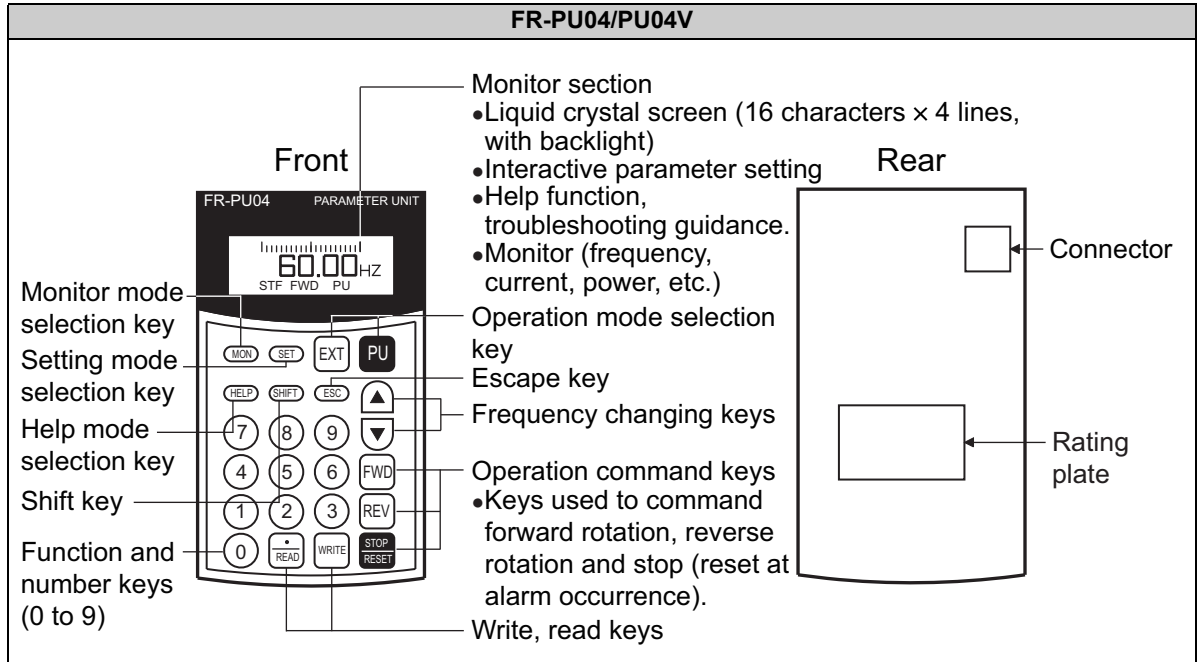



1.1.2 Appearance and parts identification



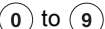

Unpack the parameter unit, check the name plate on the back, and make sure that the product has not been damaged before using.



1

1.1.3 Explanation of keys

Key	Description
	<ul style="list-style-type: none"> · Used to select the parameter setting mode. · Press to select the parameter setting mode.
	Used to display the first priority screen.
	Operation cancel key.
	<ul style="list-style-type: none"> · Used to display the help menu. · Various functions can be executed from the help menu.
	Used to shift to the next item in the setting or monitoring mode.
	Used to enter a frequency, parameter number or set value.
	Used to select the External operation mode.
	Used to select the PU operation mode to display the frequency setting screen.
	<ul style="list-style-type: none"> · Used to keep on increasing or decreasing the running frequency. Hold down to change the frequency. · Press either of these keys on the parameter setting mode screen to change the parameter setting value sequentially. · On the selecting screen, these keys are used to move the cursor. · Hold down  and press either of these keys to advance or return the display screen one page.

Key	Description
	Forward rotation command key.
	Reverse rotation command key.
	<ul style="list-style-type: none"> · Stop command key. · Used to reset the inverter when a fault occurs.
	<ul style="list-style-type: none"> · Used to write a set value in the setting mode. · Used as a clear key in the all parameter clear or alarm history clear mode.
	<ul style="list-style-type: none"> · Used as a decimal point when entering numerical value. · Used as a parameter number read key in the setting mode. · Used as an item select key on the menu screen such as parameter list or monitoring list. · Used as an alarm definition display key in the alarm history display mode. · Used as a command voltage read key in the calibration mode.
Display	16 character × 4 line liquid crystal display screen shows monitoring data, such as frequency, motor current and I/O terminal states, as well as troubleshooting guidance and other information.
Connector	Used for connection of the parameter unit with the inverter. You may either connect the unit directly or use the connection cable (FR-CB2□□) for connection.

1

CAUTION

- Do not use a sharp-pointed tool to push the keys.
- Do not press your fingers against the display.

1.2 Installation and Removal of FR-PU04/PU04V

To ensure safety, install or remove the FR-PU04/PU04V only after switching the power of the inverter OFF.

1.2.1 Direct installation to the inverter

- (1) Remove the operation panel (FR-DU04/DU-04-01).
- (2) Insert the parameter unit straight into the position and fit it securely.

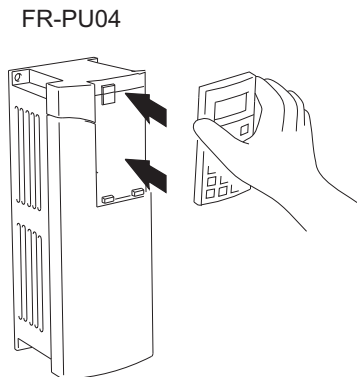

FR-A500/F500 series inverter

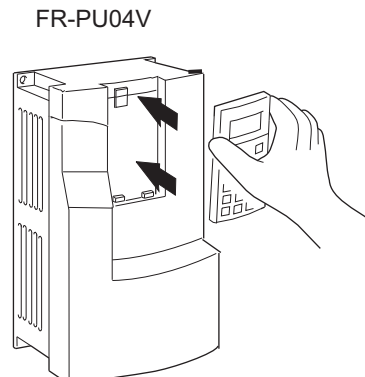

FR-V500 series inverter

REMARKS

- Direct installation of the FR-PU04 is possible only to the FR-A500/F500 series inverter. Direct installation of the FR-PU04V is possible only to the FR-V500 inverter.

1.2.2 Removal from the inverter

Tilt the parameter unit toward the front while holding down its top button, and pull it out of the hook.

FR-PU04

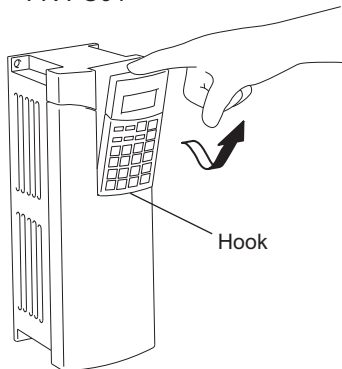

FR-A500/F500 series inverter

FR-PU04V

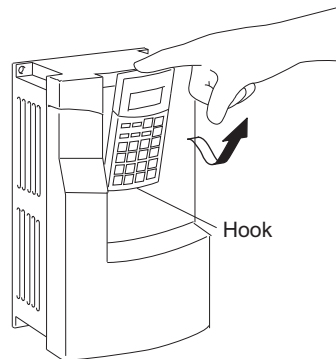

FR-V500 series inverter

1.2.3 Installation using the connection cable (FR-CB2)

For details of the connection cable (FR-CB2), refer to the instruction manual of the FR-CB2.

• Connection to the FR-A500/F500/V500/E500 series inverter

- (1) Remove the operation panel.
- (2) Insert the cable plugs into the connectors on the inverter and the parameter unit (FR-PU04/PU04V) until the tabs snap into place.

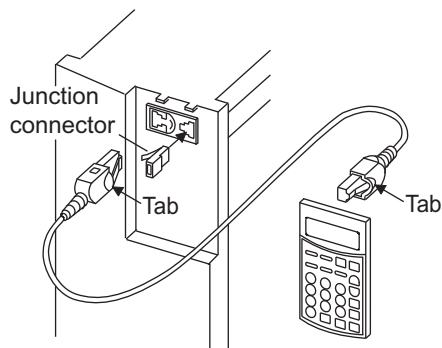

FR-A500/F500/V500 series inverter

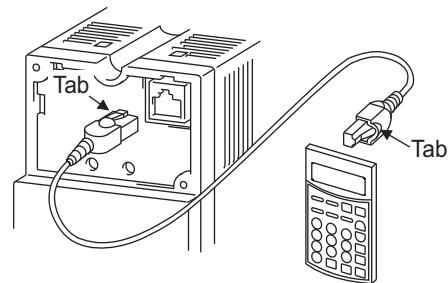

FR-E500 series inverter

CAUTION

Do not remove the inverter's front cover.

• **Connection to the FR-S500/F500J/C500 series inverter**

- (1) Remove the front cover.
- (2) Insert the cable plugs into the connectors on the inverter and the parameter unit (FR-PU04/PU04V) until the tabs snap into place.

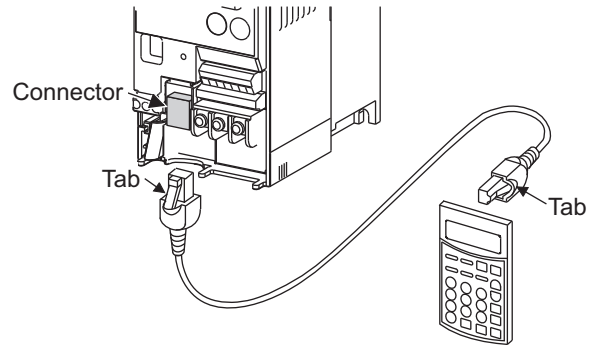

CAUTION

Do not remove the inverter's wiring cover.

REMARKS

- The cable plug can be connected after cutting off the lug of the wiring cover, allowing the plug to be inserted and removed without removing the front cover.

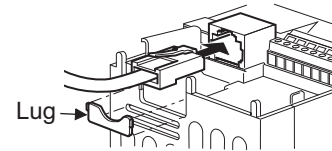

1.2.4 Removal when the connection cable (FR-CB2) is used

Hold down the tab at the cable end and gently pull the plug.

1.3 Parameters to be Checked First

Change the following parameter settings as required.

For the changing procedures, refer to *page 23*.

1.3.1 PU display language selection (Pr. 145)

By setting the *Pr. 145 PU display language selection* value, you can select the language displayed on the parameter unit.

Pr. 145 Setting	Display Language
0	Japanese
1	English
2	German
3	French
4	Spanish
5	Italian
6	Swedish
7	Finnish

1.3.2 PU buzzer control (Pr. 990)

By setting the *Pr. 990 PU buzzer control* value, you can select to either generate or mute the "beep" which sounds when you press any of the parameter unit keys.

<i>Pr. 990</i> Setting	Description
0	No buzzer sound
1 (initial value)	Buzzer sound generated

REMARKS

- Inverter alert faults with beep sounds when this parameter is set to activate the buzzer.

1.3.3 PU contrast adjustment (Pr. 991)

By setting the *Pr. 991 PU contrast adjustment* value, you can adjust the contrast for the display panel of the parameter unit.

<i>Pr. 991</i> Setting	Description
0 to 63	<div style="display: flex; align-items: center; justify-content: space-between;"> [0] [63] </div>  <div style="display: flex; justify-content: space-between; margin-top: 5px;"> Light Dark </div>

2 FUNCTIONS

2.1 Monitoring Function

2.1.1 Display overview

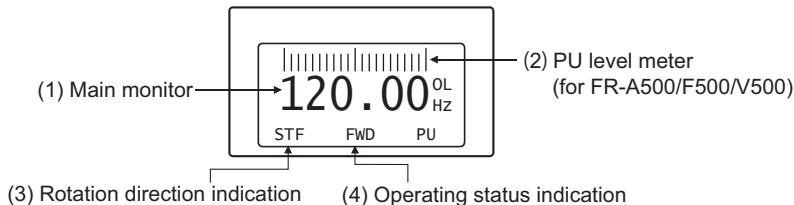

(1) Main monitor

Shows the output frequency (Hz Out), output current (I Out), output voltage (V Out), alarm history and other monitor data.

- Using **(SHIFT)** to change to the next screen (*Refer to page 15*)
- Using **(HELP)** to change to the next screen (*Refer to page 48*)
- Using the parameter "PU main display data selection" (*Refer to page 18*)

(2) PU level meter

Use *Pr. 53 PU level display data selection* to display the value for the selected data on the 5-percent scale level meter.

(For details on the parameters, refer to the instruction manual of the inverter.)

(3) Rotation direction indication

Display the direction (forward rotation/reverse rotation) of the start command.

STF: Forward rotation

STR: Reverse rotation

---: No command or both STF and STR ON

(4) Operating status indication

Display the running status of the inverter.

STOP: During stop

FWD: During forward rotation

REV: During reverse rotation

JOGf: During Jog forward rotation

JOGr: During Jog reverse rotation

ALAR: At fault occurrence

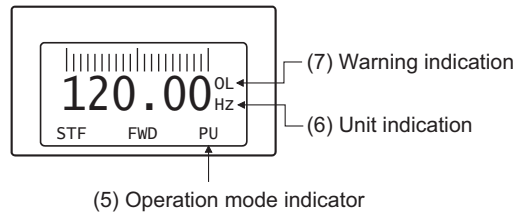

(5) Operation mode indication

Displays the status of the operation mode.

EXT: External operation mode

PU: PU operation mode

EXTj: External Jog mode

PUj: PU Jog mode

NET: Network operation mode

PU+E: External/PU combined operation mode

PRG: Programmed operation mode

(for inverters compatible with programmed operations only)

(6) Unit indication

Shows the unit of the main monitor.

(7) Warning indication

Displays an inverter warning.

The warning type varies with the inverter model.

Refer to the inverter instruction manual for details.

Nothing is displayed when there is no inverter warning.

2.1.3 Setting the power-ON monitor (the first priority monitor)

Set the monitor which appears first when power is switched ON or **MON** is pressed.











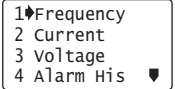

- When you press **WRITE** during any monitor screen other than ALARM HISTORY being displayed, that screen is set as the power-ON screen and will be displayed first.



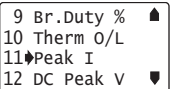

2.1.4 Using to change the main monitor

Press  to display the monitoring list while the main monitor is displayed.

Select a monitor from the monitoring list to change the main monitor.

Example: Select the output current peak value monitor.

1	Press  . The parameter unit is in the monitoring mode.	
2	Press  . The monitoring list appears.	
3	Press  /  to move the cursor to "Peak I". Hold down  and press  or  to shift one screen.	
4	Press  . *1 The output current peak is displayed.	
5	Press  . *2 The screen in step 4) is set as the first priority monitor.	Subsequently press  to call another monitor screen.

- *1 The selected monitor is not set as the first priority monitor yet when only  was pressed. Hence, the selected monitor is erased from memory as soon as the power is switched OFF or another operation mode is selected. In this case, the item must be selected again. When you press  to select the first priority screen, the selected item is stored in memory.
- *2 Pressing  sets the selected "output current peak" to be displayed in the first priority monitor when switched to the monitoring mode from other operation modes. To give first priority to another monitor screen, press  with that monitor screen being displayed. (Refer to page 16)

REMARKS

- Setting from the help menu is also available. For details refer to page 42.
- When "Current monitor" or "Power monitor" is selected, note that any current or power not more than 5% of the rated inverter current cannot be detected and displayed.
Example: When a small motor is rotated with a large-capacity inverter (a 0.4kW motor is used with a 55kW inverter), the power monitor keeps displaying 0kW and is inoperative.

2.1.5 Using the parameter to change the monitor (Pr. 52)

To change the third monitor (output voltage monitor), set *Pr. 52 DU/PU main display data selection*.

(Note that setting "17" (load meter), "18" (Motor excitation current), and "24" (Motor load ratio) change the output current monitor.

"Output voltage monitor" monitor displays from the first priority monitor using **SHIFT**.

REMARKS

- The monitor items depend on the inverter. For the monitor items and descriptions, refer to the instruction manual of each inverter.

Factory setting

* The monitor displayed at powering ON is the first priority monitor. Refer to *page 16* for the setting method of the first priority monitor.

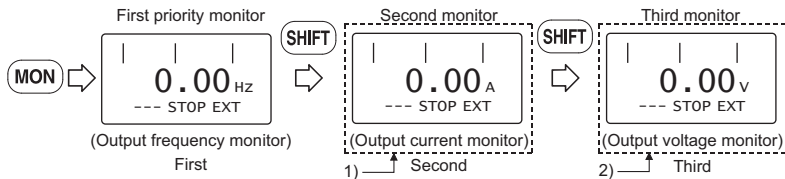

1) For the set value of "17, 18, 24", their monitors are displayed at the second monitor instead of output current monitor.

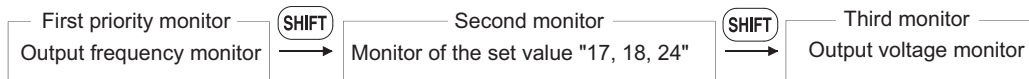

2) For the set value of "19 to 23, 25……", their monitors are displayed at the third monitor instead of output voltage monitor.



REMARKS

The setting range of *Pr. 52 DU/PU main display data selection* differs according to the inverter. Refer to the inverter instruction manual for details.

2.2 Frequency Setting

The frequency in PU operation mode and External/PU combined operation mode (*Pr. 79* = "3") can be set.

REMARKS

- When changing the operation mode from External operation mode to PU operation mode, operation mode cannot be changed if the external starting signal (STF or STR) is ON.

2.2.1 Direct setting

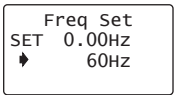
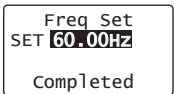

Directly enter a frequency setting using (0) to (9).

- Operation procedure (Changing from 0Hz setting to 60Hz setting)





1	Press PU . The frequency setting screen appears.	
2	Press (6) and (0). Enter 60Hz.*	
3	Press WRITE . The 60Hz setting is complete.	

- * If you entered an incorrect value, press (ESC) to return to the pre-entry state.

2.2.2 Step setting

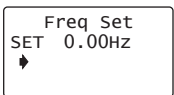

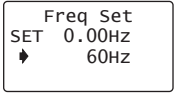
Change frequency continuously using  / .

You can change the frequency only while you press  / . Since the frequency changes slowly at first, this setting can be used for fine adjustment.

1	Press  . The frequency setting screen appears.	
2	Press  /  to enter a desired value (60.00Hz).* You can set any value between the maximum frequency (Pr: 1) and minimum frequency (Pr: 2).	
3	Press  . The 60Hz setting is complete.	

* To cancel an incorrect entry and restore the previous screen, press .

REMARKS

- Change of frequency can be made during operation by the step setting. However, pressing  /  at monitor mode may cause actual set frequency to be higher/lower from the indicated frequency on the monitor. When performing the step setting at monitor mode, make sure that output frequency is following the set frequency.

2.2.3 Precautions for frequency setting

- 1) Pr. 79 Operation mode selection must have been set to switch to the PU operation. (Refer to the inverter instruction manual for details of Pr. 79 .)
- 2) In the monitor mode, you cannot make the direct setting (Refer to page 20) to set the running frequency.

Perform the step setting (Refer to page 21) and press , or press  to display the frequency setting screen before frequency setting.

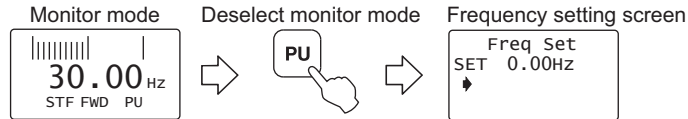



2.3 Setting and Changing the Parameter Values

Using the FR-PU04/PU04V allows you to read the parameter of inverter or change the set value easily. Refer to the inverter instruction manual for details of the parameters.

2.3.1 Specifying the parameter number to change the set value

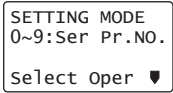
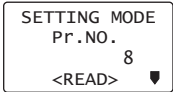
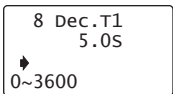
Example: When changing 5s to 180s at the *Pr. 8 Deceleration time* setting

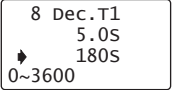
1	<p>Press PU.</p> <p>The frequency setting screen appears, and operation mode changes to PU operation mode.</p> <p>(You need not press PU when the parameter unit is already in the PU operation mode.)</p>	
2	<p>Press SET.</p> <p>The parameter unit is in the parameter setting mode.</p>	
3	<p>Press 8.</p> <p>Enter the desired parameter number.</p>	
4	<p>Press READ.</p> <p>The present setting appears.</p>	

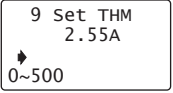
5	<p>(1) Direct setting</p> <p>Press 1 8 0.*</p> <p>Enter the desired value.</p> <p>Or</p> <p>(2) Step setting</p> <p>Press ▲ ▼.</p> <p>Display "180" using ▲ ▼.</p>	
6	<p>Press WRITE.</p> <p>The set value is changed.</p>	
7	<p>Press SHIFT to display the next parameter.</p>	

* If you entered an incorrect value, press **ESC** to return to the pre-entry state.

2.3.2 Selecting the parameter from functional list to change the set value



Example: When changing 5s to 180s at the *Pr. 8*
Deceleration time setting

1	<p>Press PU.</p> <p>The frequency setting screen appears, and operation mode changes to PU operation mode.</p>	<pre style="font-family: monospace;"> Freq Set SET 0.00Hz </pre>
2	<p>Press SET.</p> <p>The parameter unit is in the parameter setting mode.</p>	<pre style="font-family: monospace;"> SETTING MODE 0~9:Ser Pr.NO. Select Oper ▼ </pre>
3	<p>Select the screen using ▼ and move the cursor to "Appl.Grp".</p>	<pre style="font-family: monospace;"> 1▶Appl.Grp ▲ 2 Pr.List 3 User List 4 Param Copy </pre>
4	<p>Press READ.</p> <p>The function list appears.</p>	<pre style="font-family: monospace;"> 1 Basic Func 2 F Command 3▶Acc.Dec 4 V/F pattern ▼ </pre>
5	<p>Select a function. Point the cursor to "Acc.Dec" using ▼.</p>	<pre style="font-family: monospace;"> 1 Basic Func 2 F Command 3▶Acc.Dec 4 V/F pattern ▼ </pre>

6	<p>Press READ.</p> <p>A function list regarding acceleration/deceleration is displayed.</p>	<pre style="font-family: monospace;"> 1▶Acc1/Dec1 T 2 Acc1/Dec1 P 3 Brake Seq </pre>
7	<p>Select a function.</p> <p>Using ▲▼, point the cursor to "Acc1/Dec1 T".</p>	<pre style="font-family: monospace;"> 1▶Acc1/Dec1 T 2 Acc1/Dec1 P 3 Brake Seq </pre>
8	<p>Press READ.</p> <p>A parameter list regarding acceleration/deceleration time is displayed.</p>	<pre style="font-family: monospace;"> 7▶Acc.T1 8 Dec.T1 16 JOG T 20 Acc/DecF </pre>
9	<p>When moving the cursor to "Dec.T1" using ▲▼ and pressing READ, the present set value is called.</p>	<pre style="font-family: monospace;"> 8 Dec.T1 5.0s ▶ 0~3600 </pre>

2

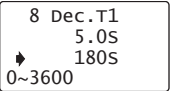
7 Setting and Changing the Parameter Values

10	<p>(1) Direct setting Press 1 8 0. *</p> <p>Enter the desired value.</p> <p>Or</p> <p>(2) Step setting Press ▲ ▼.</p> <p>Display "180" using ▲ ▼.</p>	
11	<p>Press WRITE.</p> <p>The set value is changed.</p>	
12	<p>Press SHIFT to display the next parameter.</p>	

* If **ESC** is pressed when an incorrect setting value is input, the display returns to the list display "8".

2.3.3 Selecting the parameter from parameter list to change the set value

Example: When changing 5s to 180s at the *Pr. 8*
Deceleration time setting

1	<p>Press PU.</p> <p>The frequency setting screen appears, and operation mode changes to PU operation mode.</p>	
2	<p>Press SET.</p> <p>The parameter unit is in the parameter setting mode.</p>	
3	<p>Change the screen using ▼.</p>	
4	<p>Select a parameter list.</p> <p>Using ▲▼, point the cursor to "Pr.List".</p>	
5	<p>Press READ.</p> <p>Select the parameter list.</p> <p>The list of the parameters can be read appears.</p>	

6	<p>Select the parameter.</p> <p>When moving the cursor using ▲▼ and pressing READ at "Dec.T1", the present set value is called.</p>	
7	<p>(1) Direct setting</p> <p>Press 1 8 0. *</p> <p>Enter the desired value.</p> <p>Or</p> <p>(2) Step setting</p> <p>Press ▲▼.</p> <p>Display "180" using ▲▼.</p>	
8	<p>Press WRITE.</p> <p>The set value is changed.</p>	
9	<p>Press SHIFT to display the next parameter.</p>	







* If **ESC** is pressed when an incorrect setting value is input, the display returns to the list display "5".



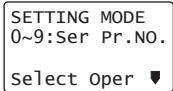

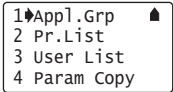

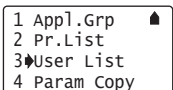

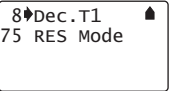
2

2.3.4 Selecting the parameter from User List to change the set value

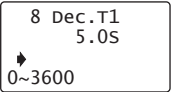
If a parameter is registered to User List, the parameter can be read from User List and changed. (For registering the user group, refer to *page 29*.)

Example: When changing 5s to 180s at the *Pr. 8*
Deceleration time setting

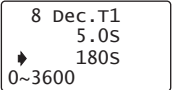
1	<p>Press PU.</p> <p>The frequency setting screen appears, and operation mode changes to PU operation mode.</p>	
2	<p>Press SET.</p> <p>The parameter unit is in the parameter setting mode.</p>	
3	<p>Change the screen using .</p>	
4	<p>Select a User List.</p> <p>Using  , point the cursor to "User List".</p>	
5	<p>Press .</p> <p>The list of the parameters registered to User List appears.</p>	

6	<p>Select the parameter.</p> <p>When moving the cursor using   and pressing  at "Dec.T1", the present set value is called.</p>	
7	<p>(1) Direct setting</p> <p>Press 1 8 0.*</p> <p>Enter the desired value.</p> <p>Or</p> <p>(2) Step setting</p> <p>Press  .</p> <p>Display "180" using  .</p>	
8	<p>Press WRITE.</p> <p>The set value is changed.</p>	
9	<p>Press SHIFT to display the next parameter.</p>	

* If **ESC** is pressed when an incorrect setting value is input, the display returns to the list display "5".

2.3.5 Precautions for setting write

- Perform parameter setting change during an inverter stop basically in the PU operation mode or combined operation mode. The parameter setting cannot be changed in the External operation mode or during inverter operation. (Read is performed independently of the operation mode.) Note that some parameters can be written even in the External operation mode or during operation. Therefore, refer to the inverter manual.
- As *Pr. 77 Parameter write selection = "0"* in the initial setting, parameter can be written only during an inverter stop. (Read is allowed even during operation.) Note that some parameters can be written always. Refer to the inverter manual for details of *Pr. 77*.
- In addition to the above case, setting write cannot be performed when:
 - 1) The parameter number selected does not exist in the parameter list; or
 - 2) The value entered is outside the setting range.
- When write cannot be performed and the "Setting Err." appears, press **(ESC)** and make setting once more. (Example: For *Pr. 7 Acceleration time*)

```
7 Acc.T1
Setting Error
20000S
<ESC>
```

2.4 User Group Function

- User group function is a function to display only parameters necessary for setting.
- Among all parameters, maximum 16 parameters can be registered to the user group. When "1" is set in *Pr. 160*, only parameters registered in the user group can be accessed for reading and writing. (The parameters not registered to the user group cannot be read.)

REMARKS

- The function may or may not be available depending on the inverter. Refer to the instruction manual of the inverter for details.

2.4.1 Registering the parameters to user group

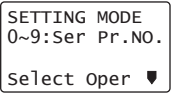
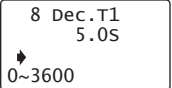
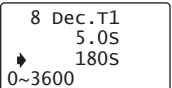
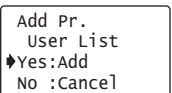
1	<p>Press SET.</p> <p>The parameter unit is in the parameter setting mode.</p>	
2	<p>Read the parameters. Enter the parameter number to be registered to the user group with the number keys and press READ to read the parameter setting.</p>	
3	<p>Set the parameters. When changing the set value, enter a new value with the number keys and press WRITE to write. When not changing the setting value, press WRITE to display the setting completion screen.</p>	
4	<p>Press WRITE.</p> <p>The selecting screen appears.</p>	

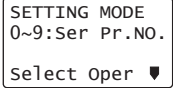
5	<p>Register. When moving the cursor to "YES" and pressing WRITE, the registration is executed.</p>	
6	<p>The parameter setting screen appears. To continue parameter registration, repeat the operation from step 2.</p>	

2.4.2 Deleting the parameters from user group

1	<p>Press SET.</p> <p>The parameter unit is in the parameter setting mode.</p>	<pre>SETTING MODE 0~9:Ser Pr.NO. Select Oper ▾</pre>
2	<p>Select "User List".</p> <p>Using ▲/▼, point the cursor to "3 User List" and press READ.</p>	<pre>1 Appl.Grp ▲ 2 Pr.List 3 User List 4 Param Copy</pre>
3	<p>Select the parameter to be deleted.</p> <p>Using ▲/▼, point the cursor to the parameter to be deleted and press WRITE.</p>	<pre>1 Max.F1 2 Min.F1 3 VFbaseF1 ▾ 7 Acc.T1</pre>
4	<p>Delete.</p> <p>The screen of delete confirmation appears. When pointing the cursor to "Yes" and pressing WRITE, the parameter is deleted.</p>	<pre>Delete Pr. User List ◆Yes:Delete No :Cancel</pre>

5	<p>To continue deleting parameter, repeat the operation from step 3.</p>	<pre>1 Max.F1 2 Min.F1 7 Acc.T1 8 Dec.T1 ▾</pre>
----------	--	--

2.4.3 Confirming the parameters registered to user group

1	<p>Press SET.</p> <p>The parameter unit is in the parameter setting mode.</p>	<pre>SETTING MODE 0~9:Ser Pr.NO. Select Oper ▾</pre>
2	<p>Select "User List".</p> <p>Using ▲/▼, point the cursor to "3 User List" and press READ.</p>	<pre>1 Appl.Grp ▲ 2 Pr.List 3 User List 4 Param Copy</pre>
3	<p>Read the parameter.</p> <p>You can confirm the parameters registered to the user group.</p>	<pre>1 Max.F1 2 Min.F1 3 VFbaseF1 7 Acc.T1 ▾</pre>

REMARKS

- If the parameter is not registered to the user group, "User List Setting Err." will be displayed. Press **ESC** to return to the screen of step 1.

2.5 Calibration of the Meter (Frequency Meter)

The functions vary with the inverter. (Refer to the inverter instruction manual for details of the parameters.)

2.5.1 Calibration of the FM terminal

Parameter

Pr. 900 FM terminal calibration





Pr. 54 FM terminal function selection

Pr. 55 Frequency monitoring reference

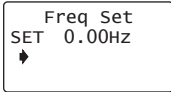
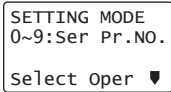
This section provides the way to calibrate the full-scale of meter connected to terminal FM using the parameter unit.

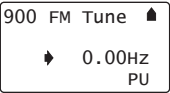
- Calibrating the meter at the running frequency of 60Hz

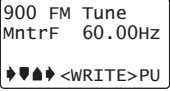
1	<p>Press PU.</p> <p>The frequency setting screen appears, and operation mode changes to PU operation mode.</p>	
2	<p>Press SET.</p> <p>The parameter unit is in the parameter setting mode.</p>	

3	<p>Enter 9 0 0 and press READ.</p> <p>The preset frequency is displayed.</p>	
4	<p>Enter 6 0 and press WRITE.</p> <p>60Hz is set.</p>	
5	<p>Press FWD.</p> <p>Forward rotation is performed at 60Hz. You need not connect the motor.</p>	
6	<p>Using ▲/▼, adjust the meter pointer to a predetermined position. The meter pointer moves. (It takes a long time before the pointer moves.)</p>	

7	Press WRITE . Calibration is complete.	
8	Press MON to return to the main monitor screen.	

2.5.2 Calibration of the AM terminal

Parameter



- Pr. 901 AM terminal calibration*
- Pr. 158 AM terminal function selection*
- Pr. 55 Frequency monitoring reference*
- Pr. 56 Current monitoring reference*

This section provides a way to calibrate the meter connected to terminal AM using the parameter unit.

(1) Calibration procedure 1

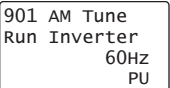
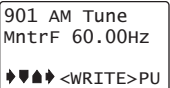
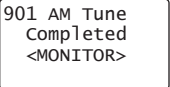

(Example: To calibrate the meter at the running frequency of 60Hz)

1	Press PU . The frequency setting screen appears, and operation mode changes to PU operation mode.	
2	Press SET . The parameter unit is in the parameter setting mode.	
3	Enter 9 0 1 and press READ . The preset frequency is displayed.	

4	Enter 6 0 and press WRITE . 60Hz is set.	
5	Press FWD . Forward rotation is performed at 60Hz. You need not connect the motor.	
6	Using ▲ / ▼ , adjust the meter pointer to a predetermined position. The meter pointer moves. (It takes a long time before the pointer moves.)	
7	Press WRITE . Calibration is complete.	
8	Press MON to return to the main monitor screen.	

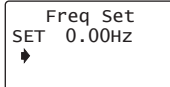
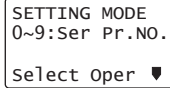
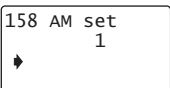

(2) When calibrating output current

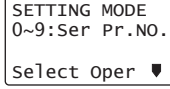
For the output current or another item, which does not easily point 100% value during operation, adjust the reference voltage output, then select the item to be displayed.

1	Press PU . The frequency setting screen appears, and operation mode changes to PU operation mode.	
2	Press SET . The parameter unit is in the parameter setting mode.	
3	Enter 1 5 8 and press READ . The present <i>Pr: 158</i> setting appears.	
4	Enter 2 1 and press WRITE . The setting of reference voltage output is complete.	
5	Press SET . The parameter unit is in the parameter setting mode.	

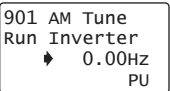
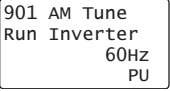
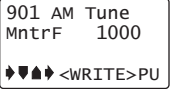
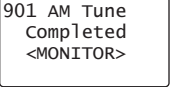
7 Calibration of the Meter (Frequency Meter)

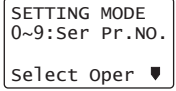
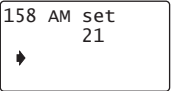
6	<p>Enter 9 0 1 and press READ.</p> <p>The present Pr. 901 setting appears.</p>	
7	<p>Enter 6 0 and press WRITE.</p> <p>The setting of maximum running frequency is complete.</p>	
8	<p>Press FWD.</p> <p>Forward rotation is performed at 60Hz.</p> <p>You need not connect the motor to make adjustment.</p>	
9	<p>Using ▲ / ▼, adjust the voltage across terminals AM-5 and press WRITE.</p> <p>Setting is complete.</p> <p>The output voltage displayed is the value at 100% output.</p> <p>This voltage is not stored if you do not press WRITE.</p>	

10	<p>Press SET.</p> <p>The parameter unit is in the parameter setting mode.</p>	
11	<p>Enter 1 5 8 and press READ.</p> <p>The present Pr. 158 setting appears.</p>	
12	<p>Enter 2 and press WRITE.</p> <p>The setting of output current is complete.</p> <p>The output current for 10VDC is the setting value of Pr. 56 <i>Current monitoring reference</i> (initial value: rated inverter current).</p>	

2.6 Adjustment of the Frequency Setting Signals "Bias" and "Gain"

The functions vary with the inverter model. (Refer to the inverter instruction manual for details of the functions.)

2.6.1 Adjustment procedure

There are three ways to adjust the bias and gain of the frequency setting voltage (current).

- (1) Adjust only the bias and gain frequencies and not adjust the voltage (current) *(Refer to page 36)*
- (2) Adjust any point by applying a voltage across terminals 2-5 (starting a current across terminals 4-5) *(Refer to page 38)*
- (3) Adjust any point without a voltage being applied across terminals 2-5 (without a current being applied across terminals 4-5) *(Page 40)*

Parameter *

Pr. 902 to Pr. 905, Pr. 917 to Pr. 920

* The parameters may or may not be available depending on the inverter. For details, refer to the instruction manual of each inverter.

- (1) Adjust only the bias and gain frequencies and not adjust the voltage

• Setting of the frequency setting voltage bias

1	Press PU . The frequency setting screen appears, and operation mode changes to PU operation mode.	
2	Press SET . The parameter unit is in the parameter setting mode.	
3	Enter 9 0 2 and press READ . The present <i>Pr. 902</i> setting appears.	

7 Adjustment of the Frequency Setting Signals "Bias" and "Gain"

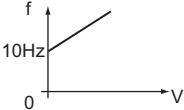
4	Enter 1 0 . Voltage need not be applied across terminals 2-5.	<pre>902 Ext2bias ↓ 10Hz Set<WRITE></pre>
5	Press WRITE . The bias frequency is set at 10Hz.  If the voltage is being applied across terminals 2- 5 at this time, the bias setting is as shown above.	<pre>902 Ext2bias ↓ 10.00Hz Completed</pre>

• Setting of the frequency setting voltage gain

6	Press SHIFT . The present setting appears.	<pre>903 Ext2gain ↓ 60.00Hz Set<WRITE> Ext<READ></pre>
7	Enter 5 0 . Voltage need not be applied across terminals 2-5.	<pre>903 Ext2gain ↓ 50Hz Set<WRITE></pre>

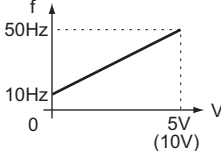
8	Press WRITE . The bias frequency is set at 50Hz. At this time, set the gain on the assumption that the 5V (10V) in the inverter is the set voltage.	<pre>903 Ext2gain ↓ 50.00Hz Completed</pre> 
---	--	--

The adjustment of the frequency setting voltage bias and gain is complete.

REMARKS

- The current input (*Pr. 904*) can also be adjusted using a similar procedure.
- The *Pr. 903 Terminal 2 frequency setting gain* remains unchanged if the *Pr. 20 Acceleration/deceleration reference frequency setting* is changed.

Adjustment of the Frequency Setting Signals "Bias" and "Gain"

(2) Adjust any point by application of voltage to across terminals 2-5

• Setting of the frequency setting voltage bias

1	<p>Press PU.</p> <p>The frequency setting screen appears, and operation mode changes to PU operation mode.</p>	
2	<p>Press SET.</p> <p>The parameter unit is in the parameter setting mode.</p>	
3	<p>Enter 9 0 2.</p>	
4	<p>Press READ twice.</p> <p>The present <i>Pr. 902</i> setting appears.</p> <p>When the set voltage is changed, the % value also changes.</p> <p>This example assumes that a 1V voltage is applied.</p> <p>The value selected in <i>Pr. 73</i> (5V in this example) is 100%.</p>	<p>1) The previous setting is displayed.</p> <p>2) The present set voltage across terminals 2-5 is displayed in %.</p>

5	<p>Enter 1 0.</p> <p>Set the bias frequency at 10Hz.</p>		
6	<p>Press WRITE.</p> <p>The cursor (▶) moves to the set voltage.</p>		
7	<p>Apply a 0V voltage.</p> <p>In this example, 0V is applied as 10Hz is set for 0V.</p> <p>(Indicated % on the right changes.)</p>		
8	<p>Press WRITE.</p> <p>The bias frequency is set at 10Hz for 0V input.</p> <p>Setting is completed as shown below:</p>		<p>0.0% of analog input value may not be displayed in some cases.</p>

7 Adjustment of the Frequency Setting Signals "Bias" and "Gain"

• Setting of the frequency setting voltage gain

<p>9</p>	<p>Press SHIFT, then READ.</p> <p>The present <i>Pr. 903</i> setting appears.</p> <p>When the set voltage is changed, the % value also changes.</p> <p>The value selected in <i>Pr. 73</i> (5V in this example) is 100%.</p>	<pre>903 Ext2gain 60.00Hz 1) 97.1% Ext 80.0% 2)</pre> <p>1) The previous setting is displayed.</p> <p>2) The present set voltage across terminals 2-5 is displayed in %.</p>
<p>10</p>	<p>Enter 5 0.</p>	<pre>903 Ext2gain 50Hz 97.1% Ext 80.0%</pre>
<p>11</p>	<p>Press WRITE.</p> <p>The cursor (▶) moves to the set voltage.</p>	<pre>903 Ext2gain 50.00Hz 97.1% Ext 80.0%</pre>
<p>12</p>	<p>Apply a 5V voltage.</p> <p>In this example, 5V is applied to set 50Hz for 5V input.</p>	<pre>903 Ext2gain 50.00Hz 97.1% Ext 80.0%</pre>

13

Press **WRITE**.

The gain frequency is set at 50Hz for 5V input. Setting is completed as shown below:

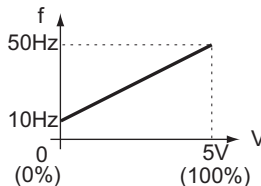

```
903 Ext2gain
  50.00Hz
  99.6%
Completed
```

The value displayed may not be just 100.0% in some cases.

The adjustment of the frequency setting voltage bias and gain is complete.

REMARKS

- The current input (*Pr. 904*, *Pr. 905*) can also be adjusted using a similar procedure.
- The *Pr. 903 Terminal 2 frequency setting gain* remains unchanged even if the *Pr. 20 Acceleration/deceleration reference frequency setting* is changed.
- A narrow calibration (command) value set using *Pr. 902* and *Pr. 903* (*Pr. 904* and *Pr. 905*) will result in "Incr II P" and disable write.

Adjustment of the Frequency Setting Signals "Bias" and "Gain"

(3) Adjust any point without application of voltage to across terminals 2-5

• Setting of the frequency setting voltage bias

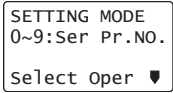
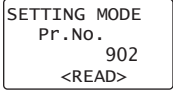
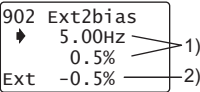
1	<p>Press PU.</p> <p>The frequency setting screen appears, and operation mode changes to PU operation mode.</p>	
2	<p>Press SET.</p> <p>The parameter unit is in the parameter setting mode.</p>	
3	<p>Enter 9 0 2.</p>	
4	<p>Press READ twice.</p> <p>The present <i>Pr. 902</i> setting appears.</p> <p>When the set voltage is changed, the % value also changes.</p> <p>The value selected in <i>Pr. 73</i> (5V in this example) is 100%.</p>	 <p>1) The previous setting is displayed.</p> <p>2) The present set voltage across terminals 2-5 is displayed in %.</p>

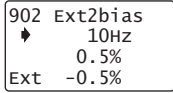
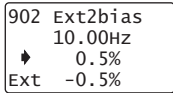
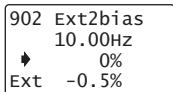
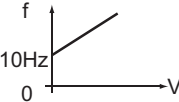
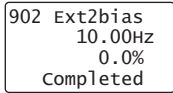
5	<p>Enter 1 0.</p> <p>Set the bias frequency at 10Hz.</p>	
6	<p>Press WRITE.</p> <p>The cursor (➡) moves to the set voltage.</p> <p>Voltage need not be applied across terminals 2-5.</p>	
7	<p>Enter 0.</p> <p>Input 0V to set bias.</p>	
8	<p>Press WRITE.</p> <p>The bias frequency is set at 10Hz.</p> <p>Setting is completed as shown below:</p> <div style="text-align: center;">  </div>	

7 Adjustment of the Frequency Setting Signals "Bias" and "Gain"

• Setting of the frequency setting voltage gain

<p>9</p>	<p>Press SHIFT, then READ.</p> <p>The present <i>Pr. 903</i> setting value appears.</p> <p>When the set voltage is changed, the % value also changes.</p> <p>The value selected in <i>Pr. 73</i> (5V in this example) is 100%.</p>	<pre>903 Ext2gain 60.00Hz 97.1% Ext 80.0%</pre> <p>1) —> 60.00Hz 2) —> 80.0%</p> <p>1) The previous setting is displayed. 2) The present set voltage across terminals 2-5 is displayed in %.</p>
<p>10</p>	<p>Enter 5 0.</p> <p>Set the gain frequency at 50Hz.</p>	<pre>903 Ext2gain 50Hz 97.1% Ext 80.0%</pre>
<p>11</p>	<p>Press WRITE.</p> <p>The cursor (➡) moves to the set voltage.</p> <p>Voltage need not be applied across terminals 2-5.</p>	<pre>903 Ext2gain 50.00Hz 97.1% Ext 80.0%</pre>
<p>12</p>	<p>Enter 1 0 0.</p> <p>Input 5V to set gain.</p>	<pre>903 Ext2gain 50.00Hz 100.0% Ext 80.0%</pre>

13

Press **WRITE**.

The gain frequency is set at 50Hz.

Setting is completed as shown below:

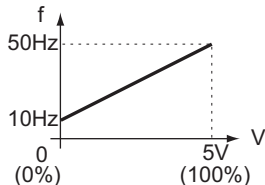

```
903 Ext2gain
  50.00Hz
  100.0%
Completed
```

The adjustment of the frequency setting voltage bias and gain is complete.

REMARKS

- The current input (*Pr. 904, Pr. 905*) can also be adjusted using a similar procedure.
- The *Pr. 903 Terminal 2 frequency setting gain* remains unchanged even if the *Pr. 20 Acceleration/deceleration reference frequency setting* is changed.
- A narrow calibration (command) value set using *Pr. 902 and Pr. 903 (Pr. 904 and Pr. 905)* will result in "Incr I/P" and disable write.

3 HELP

3.1 Overview of the Help Menu

Press **HELP** key in any operation mode to call the help menu. Various functions can be executed from the help menu.

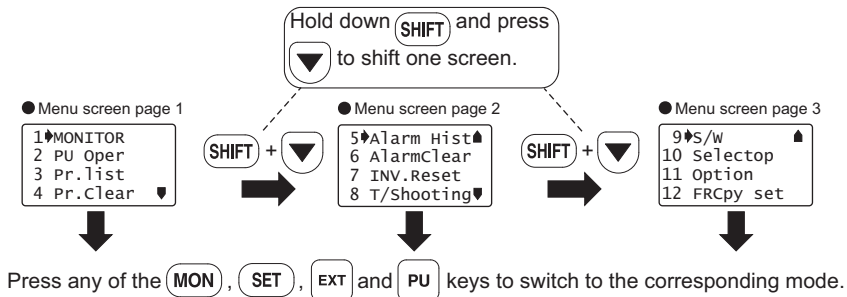

3.1.1 Help menu

Help Menu	Description	Refer To
1. MONITOR	The monitor list appears, and you can change from one monitor to another and set the first priority monitor.	Page 48
2. PU Oper	You can select the PU operation mode via direct input (direct setting with the number keys) or select the Jog operation mode from the PU, and displays how to operate the keys.	Page 49
3. Pr.List	The parameter menu appears, and you can perform "parameter setting", "list display", "parameter change list display" and "initial value list display".	Page 51

Help Menu	Description	Refer To
4. Pr.Clear	The parameter clear menu appears, and you can perform "parameter clear" and "all clear".	Page 54
5. Alarm Hist	This function displays history of past eight faults (alarms).	Page 56
6. AlarmClear	This function clears all the fault (alarm) history.	Page 57
7. Inv.Reset	This function resets the inverter.	Page 58
8. T/Shooting	The inverter displays the cause of mismatch between inverter operation and control/setting or the cause of an inverter fault. This menu is used for the FR-A500/F500 series only. Selecting this menu for the other models results in an error.	Page 58
9. S/W	This function displays the software control number of the inverter.	-
10. Selectop	This function displays the signals assigned to the I/O terminals of the control circuit and the ON/OFF states of the signals.	Page 63
11. Option	This function displays the option fitting states of the option connectors 1 to 3.	Page 64
12. FRCpy set	The function can perform the "parameter copy" (read, write, verification).	Page 65

REMARKS

- The validity of each help menu depends on the inverter model.

3.1.2 Help menu transition

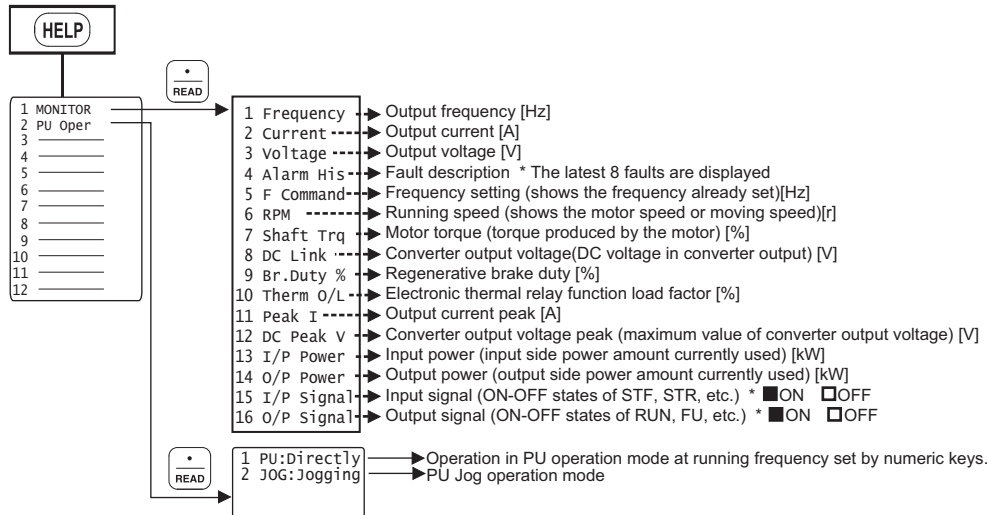

REMARKS

- The validity of each help menu depends on the inverter model.

7 Overview of the Help Menu

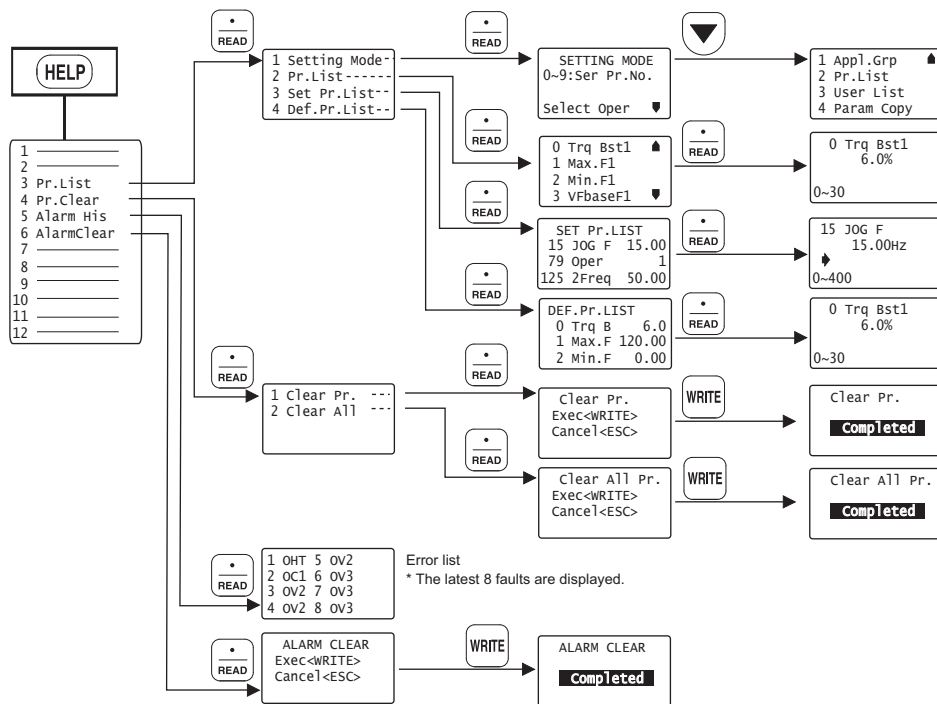

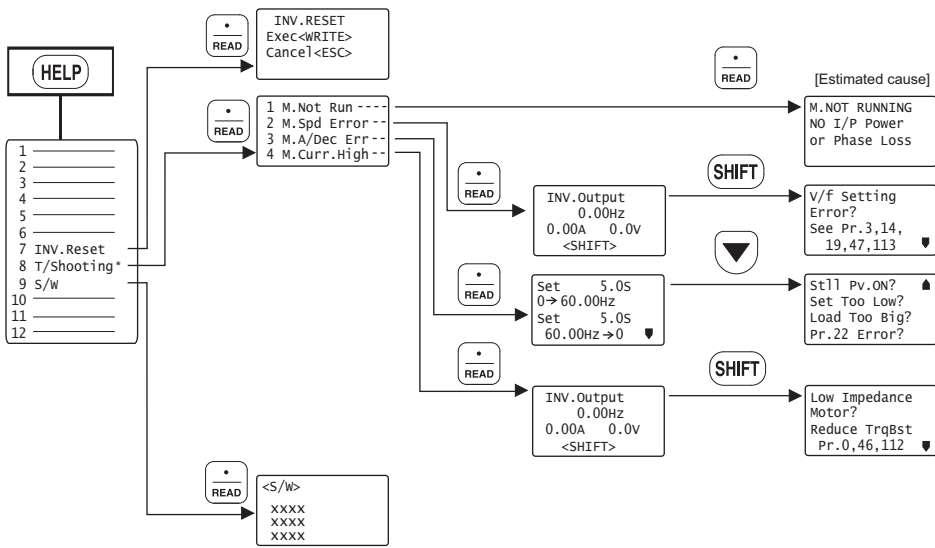

* This menu is used for the FR-A500/F500 series only. Selecting this menu for the other models results in an error.



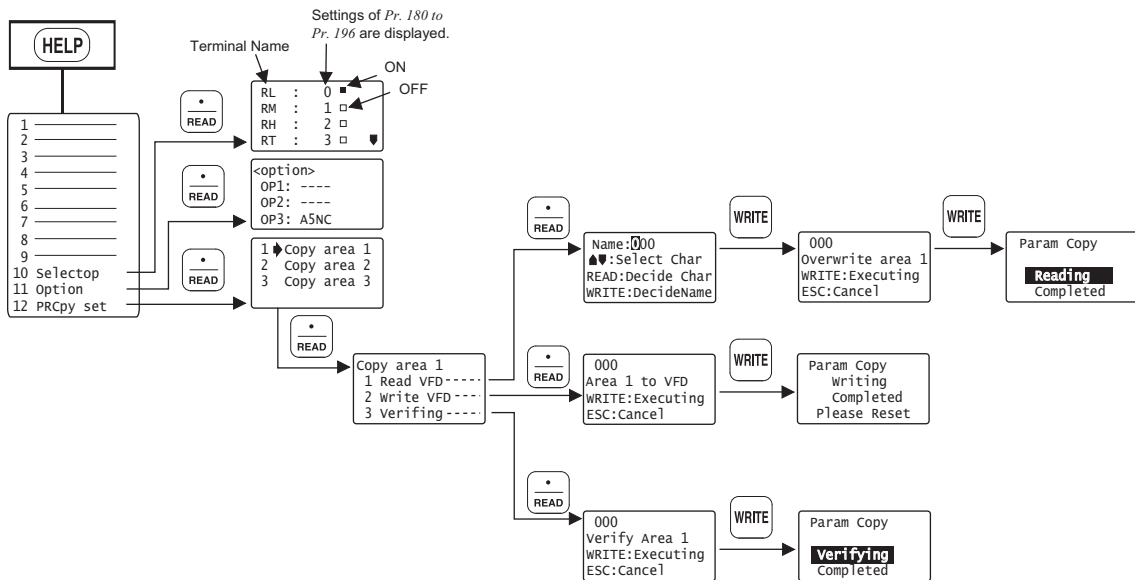



7 Overview of the Help Menu



3.2 Operation Procedures for the Help Menu

3.2.1 Monitor function

The monitoring list appears and you can change from one monitor screen to another and set the first priority screen.

1	Press HELP . The help menu appears.	
2	Make sure that the cursor is located at "1 MONITOR". If not, move the cursor with  /  .	1 MONITOR 2 PU Oper 3 Pr.List 4 Pr.Clear ▾
3	Press  . The monitoring list is called.	1 Frequency 2 Current 3 Voltage 4 Alarm His ▾
4	Press  or  to move the cursor to the desired item. Hold down SHIFT and press  /  to shift one screen.	1 Frequency 2 Current 3 Voltage 4 Alarm His ▾

5	Press  . The monitor screen selected by the cursor appears. Press WRITE to give the first priority to this monitor screen.	I Out READ:List 0.00 A --- STOP PU
----------	--	---

REMARKS

- The monitoring list can be called only with pressing  in the monitoring mode. (Refer to page 17)
- "4 Alarm His" cannot be set to the first priority monitor.
- Some monitoring items are not displayed depending on the connected inverter. To check the available monitoring items, refer to the setting range of Pr. 52 DU/PU main display data selection of the inverter.

3.2.2 Selection of PU operation (direct input)

You can select the PU operation mode to set PU operation frequency.

1	Press HELP . The help menu appears.	<div style="border: 1px solid black; padding: 5px; width: fit-content;"> 1 MONITOR 2 PU Oper 3 Pr.List 4 Pr.Clear ▾ </div>
2	Using ▼ , move the cursor to "2 PU Oper".	<div style="border: 1px solid black; padding: 5px; width: fit-content;"> 1 MONITOR 2 PU Oper 3 Pr.List 4 Pr.Clear ▾ </div>
3	Press READ . The menu on the right appears.	
4	Make sure that the cursor is located at "1 PU: Directly". If not, move the cursor with ▲ / ▼ .	<div style="border: 1px solid black; padding: 5px; width: fit-content;"> 1 PU: Directly 2 JOG: Jogging </div>
5	Press READ . The PU operation mode is selected and the frequency setting screen appears.	<div style="border: 1px solid black; padding: 5px; width: fit-content;"> Freq Set SET 0.00Hz ▾ 0~400Hz </div>

6	Enter the set frequency using 0 to 9 and press WRITE . The frequency setting is complete.	<div style="border: 1px solid black; padding: 5px; width: fit-content;"> Freq Set SET 60.00Hz Completed </div>
7	Press FWD / REV to perform forward or reverse rotation with the set frequency.	<div style="border: 1px solid black; padding: 5px; width: fit-content;">  60.00 Hz STF FWD PU </div>

REMARKS

- Press **PU** to call the frequency setting screen any time.

3.2.3 Selection of the PU Jog operation mode

You can select the PU Jog operation mode to set PU jog frequency.

1	Press HELP . The help menu appears.	<div style="border: 1px solid black; padding: 5px;"> 1 MONITOR 2 PU Oper 3 Pr.List 4 Pr.Clear ▾ </div>
2	Using ▼ , move the cursor to "2 PU Oper".	<div style="border: 1px solid black; padding: 5px;"> 1 MONITOR 2 ▾PU Oper 3 Pr.List 4 Pr.Clear ▾ </div>
3	Press READ . The menu on the right appears.	<div style="border: 1px solid black; padding: 5px;"> 1 ▾PU:Directly 2 JOG:Jogging </div>
4	Using ▼ , move the cursor to "2 JOG: Jogging".	<div style="border: 1px solid black; padding: 5px;"> 1 PU:Directly 2 ▾JOG:Jogging </div>
5	Press READ . The PU Jog operation mode is selected, and the frequency setting screen appears.	<div style="border: 1px solid black; padding: 5px;"> PU/JOG SET 0.00Hz ▾ </div>

6	Enter the set frequency using 0 to 9 and press WRITE . The PU Jog frequency setting is complete.	<div style="border: 1px solid black; padding: 5px;"> PU/JOG SET 5.00Hz Completed </div>
7	Hold down FWD / REV to perform forward or reverse rotation with the PU Jog set frequency.	<div style="border: 1px solid black; padding: 5px;"> <div style="display: flex; justify-content: space-between; width: 100%;"> </div> <div style="text-align: center; font-size: 24px; font-weight: bold;">5.00</div> <div style="text-align: center; font-size: 18px;">Hz</div> <div style="text-align: center; font-size: 12px;">STR JOGr PUj</div> </div>

REMARKS

- Press **SHIFT** to call the PU Jog frequency setting screen any time after pressing **PU**.

3.2.4 Parameters

When the parameter on the help menu is selected, the parameter menu appears, and you can select the following operations for the parameters.

	Display	Description
1	Setting Mode	Switches to the parameter setting mode to read and write the parameter setting.
2	Pr. List	Displays the parameters list. You can select the parameter from the list to read and write the parameter setting.
3	Set Pr. List	Lists the parameters whose setting is changed from initial value. You can select the parameter from the list to read and write the parameter setting.
4	Def.Pr. List	Displays the parameters and initial value list. You can select the parameter from the list to read and write the parameter setting.
5	Def. Pr. List 2 *	Displays the list of user's settings for initial value (settings of the parameters selected with <i>Pr. 199 User's initial value setting</i>).

* This function is supported by the FR-PU04 only.

(1) Setting Mode

1	Press HELP . The help menu appears.	<div style="border: 1px solid black; padding: 5px;"> 1 MONITOR 2 PU Oper 3 Pr.List 4 Pr.Clear ▾ </div>
2	Using ▼ , move the cursor to "3 Pr. List".	<div style="border: 1px solid black; padding: 5px;"> 1 MONITOR 2 PU Oper 3 Pr.List 4 Pr.Clear ▾ </div>
3	Press READ . The parameter menu appears.	<div style="border: 1px solid black; padding: 5px;"> 1 Setting Mode 2 Pr.List 3 Set Pr.List 4 Def.Pr.List </div>
4	Press READ . The parameter unit switches to the setting mode. Refer to <i>page 23</i> to set the parameters.	<div style="border: 1px solid black; padding: 5px;"> SETTING MODE 0~9:Ser Pr.NO. Select Oper ▾ </div>





(2) Pr.List

1	Call the parameter menu similarly to above steps 1 to 3.	<div style="border: 1px solid black; padding: 5px;"> 1 Setting Mode 2 Pr.List 3 Set Pr.List 4 Def.Pr.List </div>
----------	--	---

2	Using ▼ , move the cursor to "2 Pr. List".	<div style="border: 1px solid black; padding: 5px;"> 1 Setting Mode 2 Pr.List 3 Set Pr.List 4 Def.Pr.List </div>
3	Press READ . The parameter menu appears.	
4	Press ▲ / ▼ to move the cursor to the desired parameter. Press SHIFT and ▼ together to shift to the next page.	<div style="border: 1px solid black; padding: 5px;"> 0 Trq Bst1 ▲ 1 Max.F1 2 Min.F1 3 VfbaseF1 ▾ </div>
5	Press READ . The parameter indicated by the cursor is read, and the parameter unit is in the parameter setting mode. Refer to <i>page 23</i> to set the parameters.	<div style="border: 1px solid black; padding: 5px;"> 0 Trq Bst1 6.0% 0~30 ▾ </div>





Press **SHIFT** to move to the next parameter.

(3) Set Pr.List

1	Call the parameter menu similarly to steps 1 to 3 of <i>page 52</i> .	<pre> 1▶Setting Mode 2 Pr.List 3 Set Pr.List 4 Def.Pr.List </pre>
2	Using  /  , move the cursor to "3 Set Pr. List".	<pre> 1 Setting Mode 2 Pr.List 3▶Set Pr.List 4 Def.Pr.List </pre>
3	Press  . The change list appears. When the parameter has been changed from the initial value, the new value is displayed.	<pre> SET Pr.LIST 1▶Max.F1 0.00 18 Max.F2 0.00 125 2Freq 50.00 </pre>
4	Press  . The parameter indicated by the cursor is read, and the parameter unit is in the parameter setting mode. Refer to <i>page 23</i> to set the parameters.	<pre> 1 Max.F1 0.00Hz ▶ 0~120 </pre>

(4) Def.Pr.List/Def. Pr. List 2

The initial values of parameters are displayed.

1	Call the parameter menu similarly to steps 1 to 3 of <i>page 52</i> .	<pre> 1▶Setting Mode 2 Pr.List 3 Set Pr.List 4 Def.Pr.List </pre>
2	Using  /  , move the cursor to "4 Def. Pr. List". *1	<pre> 1 Setting Mode 2 Pr.List 3 Set Pr.List 4▶Def.Pr.List </pre>
3	Press  . The initial value list appears. *2	<pre> DEF.Pr.LIST 0▶Trq B 6.0 1 Max.F 120.00 2 Min.F 0.00 </pre>
4	Press  . The parameter indicated by the cursor is read, and the parameter unit is in the parameter setting mode. Refer to <i>page 23</i> to set the parameters.	<pre> 0 Trq Bst1 6.0% ▶ 0~30 </pre>

*1 To display the "Def. Pr. List 2", move the cursor to "5 Def. Pr. List 2".

*2 When "Def. Pr. List 2" is not registered, "No Changes" appears.







3.2.5 Parameter clear

You can perform the "parameter clear" and "all parameter clear".

Switch to the PU operation mode before performing any operation.





- Clear Pr. Returns (initializes) the parameters to the factory settings with the exception of the some parameters (*Pr. 75* and calibration values in *Pr. 900 to 905*).
- Clear All..... Initializes all parameters with the exception of *Pr. 75*.

(1) Parameter clear

1	Press HELP . The help menu appears.	<div style="border: 1px solid black; padding: 5px;"> 1 MONITOR 2 PU Oper 3 Pr.List 4 Pr.Clear ▾ </div>
2	Using  /  , move the cursor to "4 Pr. Clear".	<div style="border: 1px solid black; padding: 5px;"> 1 MONITOR 2 PU Oper 3 Pr.List 4 Pr.Clear ▾ </div>
3	Press  . The parameter menu appears.	<div style="border: 1px solid black; padding: 5px;"> 1 Clear Pr. 2 Clear All </div>
4	Select the "Clear Pr." Using  /  , move the cursor to "1" and press the  .	<div style="border: 1px solid black; padding: 5px;"> 1 Clear Pr. 2 Clear All </div>

5	"Clear Pr." is selected, and the confirmation screen for clearing execution is displayed.	<div style="border: 1px solid black; padding: 10px;"> Clear Pr. Exec<WRITE> Cancel<ESC> </div>
6	Press  . The parameters are initialized. When canceling the initialization, press ESC on the confirmation screen.	<div style="border: 1px solid black; padding: 10px;"> Clear Pr. <div style="background-color: black; color: white; padding: 2px; display: inline-block; font-weight: bold;">Completed</div> </div>

(2) All parameter clear

1	<p>Call the parameter menu similarly to steps 1 to 3 of <i>page 54</i>.</p>	<pre>1↓Clear Pr. 2 Clear All</pre>
2	<p>Select the "Clear All".</p> <p>Using /, move the cursor to "2 Clear All" and press the .</p>	<pre>1 cClear Pr. 2↓Clear All</pre>
3	<p>"Clear All" is selected, and the confirmation screen for clearing execution is displayed.</p>	<pre>cClear All Pr. Exec<WRITE> Cancel<ESC></pre>
4	<p>Press .</p> <p>The parameters are initialized.</p> <p>When canceling the initialization, press  on the confirmation screen.</p>	<pre>Clear All Pr. Completed</pre>

3.2.6 Alarm history

Shows the history of past eight faults.

1	<p>Press HELP. The help menu appears.</p>	<pre>1 MONITOR 2 PU Oper 3 Pr.List 4 Pr.Clear ▾</pre>
2	<p>Using ▲/▼, move the cursor to "5 Alarm His". Hold down SHIFT and press ▲/▼ to shift one screen.</p>	<pre>5 Alarm His ▲ 6 AlarmClear 7 INV.Reset 8 T/Shooting ▾</pre>
3	<p>Press READ. The fault history appears.</p>	<pre>1 OHT 5 OV2 2 SER 6 OV3 3 OV2 7 OV3 4 OV2 8 OV3</pre>
4	<p>Press READ. The running frequency at fault occurrence is displayed.</p>	<pre>LATEST ERR OH Fault 0.00Hz ▾</pre>
5	<p>Press ▼. The output current, output voltage and cumulative energization time at fault occurrence is displayed.</p>	<pre>LATEST ERR ▲ 0.00A 0.0V 7hr</pre>

6	<p>Press READ when displaying the operation mode for fault occurrence in steps 4 and 5 to display the operation data for the preceding fault occurrence.</p>	<pre>2nd Prev.ERR PU Leave Out 0.00Hz ▾</pre>
---	---	---

3.2.7 Alarm clear

Clears all the fault history.

1	<p>Press HELP.</p> <p>The help menu appears.</p>	<pre> 1 MONITOR 2 PU Oper 3 Pr.List 4 Pr.Clear </pre>
2	<p>Using ▲/▼, move the cursor to "6 AlarmClear".</p> <p>Hold down SHIFT and press ▲/▼ to shift one screen.</p>	<pre> 5 Alarm His ▲ 6 AlarmClear 7 INV.Reset 8 T/Shooting ▼ </pre>
3	<p>Press READ.</p> <p>"AlarmClear" is selected, and the confirmation screen for clearing is displayed.</p>	<pre> ALARM CLEAR Exec<WRITE> Cancel<ESC> </pre>
4	<p>Press WRITE.</p> <p>The fault history is cleared. When canceling the clear, press ESC on the confirmation screen.</p>	<pre> ALARM CLEAR Completed </pre>

3.2.8 Inverter reset

Resets the inverter.

1	<p>Press HELP.</p> <p>The help menu appears.</p>	<div style="border: 1px solid black; padding: 5px;"> <p>1 MONITOR 2 PU Oper 3 Pr.List 4 Pr.Clear ▾</p> </div>
2	<p>Using ▲/▼, move the cursor to "7 INV. Reset".</p> <p>Hold down SHIFT and press ▲/▼ to shift one screen.</p>	<div style="border: 1px solid black; padding: 5px;"> <p>5 Alarm His ▲ 6 AlarmClear 7 INV.Reset 8 T/Shooting ▾</p> </div>
3	<p>Press READ.</p> <p>"INV. Reset" is selected, and the confirmation screen for reset is displayed.</p>	<div style="border: 1px solid black; padding: 5px;"> <p>INV.RESET Exec<WRITE> Cancel<ESC></p> </div>
4	<p>Press WRITE.</p> <p>The inverter is reset, and the parameter unit switches to the monitoring mode.</p> <p>When canceling the inverter reset, press ESC on the confirmation screen.</p>	<div style="border: 1px solid black; padding: 10px; text-align: center;"> <p> </p> <p>0.00 Hz</p> <p>--- STOP EXT</p> </div>

REMARKS

- If the inverter's protective function is activated to bring the inverter to trip (output shutoff), execute the inverter reset only by pressing **STOP RESET**.
- A similar reset operation may also be performed by switching power ON again or by switching the RES signal ON. (Refer to the inverter instruction manual for details.)

3.2.9 Troubleshooting

If the inverter appears to operate improperly, perform the following operation to display the most likely cause of the fault.

This operation may also be performed during inverter operation (PU operation, External operation) or during trip (protection activated).

1	<p>Press HELP.</p> <p>The help menu appears.</p>	<div style="border: 1px solid black; padding: 5px;"> <p>1 MONITOR 2 PU Oper 3 Pr.List 4 Pr.Clear ▼</p> </div>
2	<p>Using ▲/▼, move the cursor to "8 T/Shooting".</p> <p>Hold down SHIFT and press ▲/▼ to shift one screen.</p>	<div style="border: 1px solid black; padding: 5px;"> <p>5 Alarm His ▲ 6 AlarmClear 7 INV.Reset 8 T/Shooting ▼</p> </div>
3	<p>Press READ.</p> <p>The fault menu appears.</p>	<div style="border: 1px solid black; padding: 5px;"> <p>1 M.Not Run 2 M.Spd Error 3 M.A/Dec Err 4 M.Curr.High</p> </div>
4	<p>Press ▲ or ▼ to move the cursor to the desired item.</p>	<div style="border: 1px solid black; padding: 5px;"> <p>1 M.Not Run 2 M.Spd Error 3 M.A/Dec Err 4 M.Curr.High</p> </div>

5	<p>Press READ.</p> <p>The estimated cause of the fault is displayed. (Refer to page 60)</p>	<div style="border: 1px solid black; padding: 5px;"> <p>M.SPEED ERROR SetF>Max.F1/F2 60.00Hz Pr.1/18</p> </div>
----------	--	---

REMARKS

- This menu is used for the FR-A500/F500 series only. Selecting this menu for the other models results in an error.

Troubleshooting guidance

1) M.NOT RUNNING (Motor does not run)

M.NOT RUNNING
ALARM
Indicated
<SHIFT>

The protective function is activated to bring the inverter to trip.
Press **(SHIFT)** to display the cause of the trip.

M.NOT RUNNING
Max. Fl<StartF
Pr. 1 Pr. 13

The inverter cannot start because the inverter starting frequency (*Pr. 13*) is higher than the maximum frequency (*Pr. 1*).

M.NOT RUNNING
NO I/P Power
or Phase Loss

The inverter's main circuit power has decreased or a phase in the power supply is lost. Check the power supply.

M.NOT RUNNING
EnableFR Set
See Pr. 78

The inverter cannot start because you attempted to run the motor in the direction in which forward or reverse rotation is inhibited as set in *Pr. 78*.

M.NOT RUNNING
STF, STR
both are OFF
or ON

Both start signals STF and STR are ON or OFF.

M.NOT RUNNING
Current Limit
Activated
<SHIFT>

The inverter cannot start since the current limit function is activated. Press **(SHIFT)** to display the estimated cause that the current limit function was activated.

M.NOT RUNNING
MRS is ON

MRS signal is ON.

M.NOT RUNNING
Under
PID Control

The inverter does not start because the inverter need not start the motor as a result of the arithmetic operation of PID control.

M.NOT RUNNING
SetF<StartF
Pr. 13

The inverter starting frequency (*Pr. 13*) setting is higher than the frequency currently set.

M.NOT RUNNING
CS is OFF
See Pr. 57

The inverter will not restart since the automatic restart after instantaneous power failure select signal CS is OFF. It is estimated that an instantaneous power failure has occurred or the inverter in the commercial power supply switch-over operation mode.

M.NOT RUNNING
AU is OFF

The current input select signal AU remains OFF. (not ON)

M.NOT RUNNING
NO Command
From PU

Neither of **(FWD)** and **(REV)** are pressed in the PU operation mode.

2) M.SPEED ERROR

(Speed does not match the running frequency setting)

M. SPEED ERROR
SetF>MaxF1/F2
60.00 Hz
Pr.1/18

Since the running frequency setting is higher than the maximum frequency (Pr. 1) setting, the running frequency remains at the maximum frequency.

M. SPEED ERROR
SetF<MinF1
60.00Hz
Pr.2

Since the running frequency setting is lower than the minimum frequency (Pr. 2) setting, the running frequency has been increased to the minimum frequency.

M. SPEED ERROR
Fjump Working
See Pr. 31-36
SetF= 60.00Hz

Since the running frequency setting is within the frequency jump setting range (Pr. 31 to 36), the running frequency has jumped.

M. SPEED ERROR
Current Limit
Activated
<SHIFT>

The current limit function was activated and forced the running frequency to reduce. Press (SHIFT) to display the cause that the current limit function was activated.

M. SPEED ERROR
Under
PI-Control

As a result of arithmetic operation of PID control, the running frequency differs from the set value.

3) M.A/Dec Err

(Actual acceleration/deceleration time is longer than the Pr. 7/Pr. 8 setting)

Set 5.0s
0 60.00Hz
Set 5.0s
60.00Hz 0

Acceleration time setting (Pr. 7) is displayed.

Frequency reached in the above set time (Pr. 20 Acceleration/deceleration reference frequency) is displayed.

Deceleration time setting (Pr. 8) is displayed.

Frequency from which deceleration is made in the above set time (Pr. 20 Acceleration/deceleration reference frequency) is displayed.



St11 Pv. ON?
Set Too Low?
Load Too Big?
Pr. 22 Error?

Estimated cause that actual acceleration/deceleration time is longer than the setting is displayed.

4) M.Curr.High (Inverter output current is larger than normal)

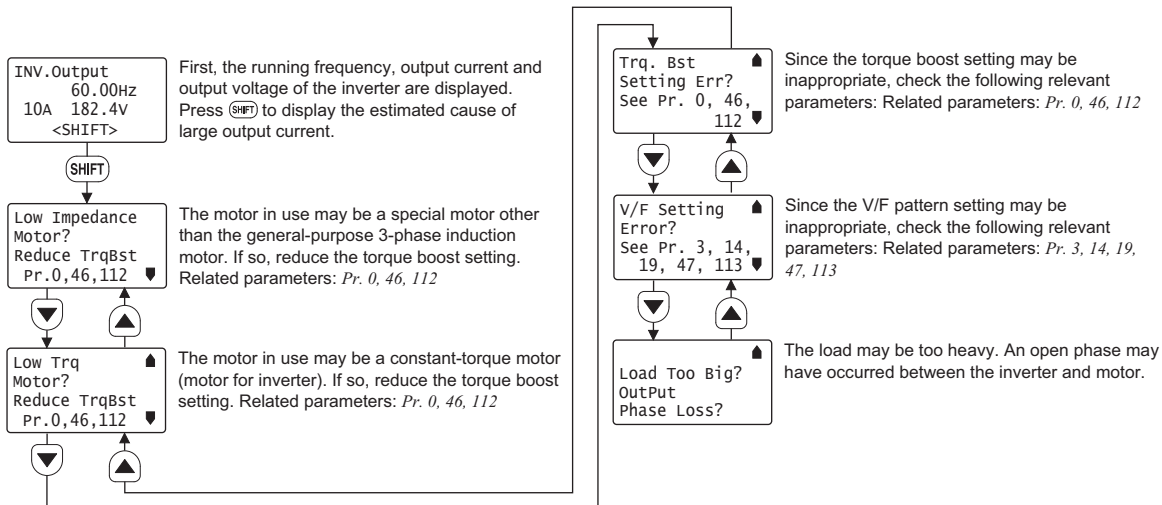

REMARKS

<When the fault could not be identified>

When the cause of the fault is not specified even after performing the operation mentioned above, the current running frequency, output current and output voltage at the point are displayed on the screen.

Press **(SHIFT)** to display the estimated cause related.

INV. Output
60.00Hz
0.00A 182.8V
<SHIFT>

3.2.10 Terminal assignment (Selectop)





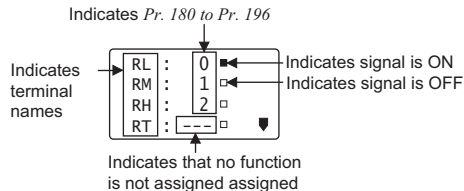

The signals assigned to the control circuit terminals and their ON-OFF state are displayed.
 The terminal status of the plug-in option can be checked if a plug-in option FR-A5AX/A5AY/A5AR is installed.

1	Press HELP . The help menu appears.	1♦MONITOR 2 PU Oper 3 Pr.List 4 Pr.Clear ▾
2	Using ▲ / ▼ , move the cursor to "10 Selectop". Hold down SHIFT and press ▲ / ▼ to shift one screen.	9 S/W ▲ 10♦Selectop 11 Option 12 PRCpy set
3	Press READ . The signals assigned to the control circuit terminals and their ON-OFF states are displayed.	RL : 0 □ RM : 1 □ RH : 2 □ RT : 3 □ ▾



3.2.11 Option

Displays what options are fitted to the option connectors.

<p>1</p>	<p>Press .</p> <p>The help menu appears.</p>	<div style="border: 1px solid black; padding: 5px;"> <p>1♦MONITOR 2 PU Oper 3 Pr.List 4 Pr.Clear ▾</p> </div>
<p>2</p>	<p>Using /, move the cursor to "11 Option".</p> <p>Hold down  and press / to shift one screen.</p>	<div style="border: 1px solid black; padding: 5px;"> <p>9 S/W ▲ 10 Selectop 11♦Option 12 PRCpy set</p> </div>
<p>3</p>	<p>Press .</p> <p>Numbers OP1 to OP3 correspond to numbers 1 to 3 of the option slot on the inverter side.</p> <p>For the inverter with only one option slot, mounted option is displayed next to OP1.</p> <p>The plug-in option which is mounted on the inverter is displayed.</p>	<div style="border: 1px solid black; padding: 5px;"> <p><option> OP1: ---- OP2: ---- OP3: A5NC</p> </div>

3.2.12 Multiple copies

(1) Copying the parameter settings

Inverter parameter settings can be read. The settings of a maximum of three inverters can be stored in FR-PU04/PU04V. You can also copy the stored parameter settings to another inverter of the same series.

Confirm for setting

- Is the *Pr: 77* setting of the copy destination inverter correct? → Set "0 or 2" in *Pr: 77*.
 - Is the inverter of the copy destination the same series as that of the copy source? → Select the inverter of the same series.
- Example: ○ FR-A520-0.4K → FR-A520-0.75K Parameters can be copied only to the
 × FR-A520-0.4K → FR-F520-0.75K same series inverters.









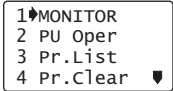

CAUTION



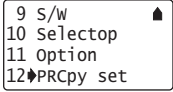

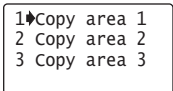

Turning power OFF during parameter copy (read, write) as below, processing is not completely ended.

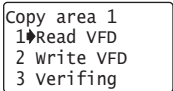
Perform parameter copy again.

- Turn OFF the inverter power.
 - Remove the FR-PU04/PU04V from the inverter.
 - Pull out the PU cable.
-
-

- Reading the parameter settings of the inverter and storing them to FR-PU04/PU04V.

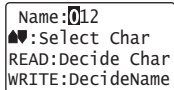
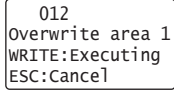
1	Connect the FR-PU04/PU04V to the copy source inverter.	
2	Press HELP . The help menu appears.	
3	Select the "PRCpy set". Using  /  , move the cursor to "12 PRCpy set" and press  .	
4	Select the copy area. The copy area selection screen is displayed. Then, move the cursor to any one of 1 to 3 and press  . (Parameter settings of each inverter (three inverters in total) can be copied to the area 1, 2 or 3.)	
5	Select the "READ". Using  /  , move the cursor to "1 Read VFD" and press  .	

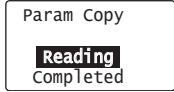
6	Give a name. You can name each of copy areas 1 to 3. Select the characters with  /  and set them with  . Press  to set the name for the area.	
7	Write to the copy area of FR-PU04/PU04V. The screen for confirming the overwriting of the data in the FR-PU04/PU04V is displayed.	
8	Press  . The parameter settings of the inverter are stored. When canceling, press  .	

7 Operation Procedures for the Help Menu

- Writing the parameter setting stored in FR-PU04/PU04V to the inverter

1	<p>Connect the FR-PU04/PU04V to the copy destination inverter.</p> <ul style="list-style-type: none"> · Is the PU operation mode selected? → If not, press PU to select the PU operation mode. · Is the inverter stopped? → If it is running, press STOP RESET to stop it.
2	<p>Press HELP.</p> <p>The help menu appears.</p> <div data-bbox="496 420 675 515" style="border: 1px solid black; padding: 5px;"> <p>1 MONITOR 2 PU Oper 3 Pr.List 4 Pr.Clear ▾</p> </div>
3	<p>Select the "PRCpy set".</p> <p>Using ▲/▼, move the cursor to "12 PRCpy set" and press READ.</p> <div data-bbox="496 567 675 663" style="border: 1px solid black; padding: 5px;"> <p>9 S/W ▲ 10 Selectop 11 Option 12 PRCpy set</p> </div>
4	<p>Select the copy area.</p> <p>Point the cursor to the copy area that stores the parameter settings to be written to the inverter, and press READ.</p> <div data-bbox="496 743 675 839" style="border: 1px solid black; padding: 5px;"> <p>1 Copy area 1 2 Copy area 2 3 Copy area 3</p> </div>

5	<p>Select the "WRITE".</p> <p>Using ▲/▼, point the cursor to "2 Write VFD" and press READ.</p>	<div data-bbox="1151 135 1330 231" style="border: 1px solid black; padding: 5px;"> <p>Copy area 1 1 Read VFD 2 Write VFD 3 Verifying</p> </div>
6	<p>Writing the parameter settings is selected, and the confirmation screen for writing is displayed.</p>	<div data-bbox="1151 275 1330 370" style="border: 1px solid black; padding: 5px;"> <p>012 Area 1 to VFD WRITE:Executing ESC:Cancel</p> </div>
7	<p>Press WRITE.</p> <p>The parameter settings stored in the FR-PU04/PU04V are copied to the copy destination inverter.</p>	<div data-bbox="1151 439 1330 534" style="border: 1px solid black; padding: 5px;"> <p>Param Copy writing Completed Please Reset</p> </div>
8	<p>Reset the inverter. (Refer to page 58)</p>	

REMARKS









- Overwriting the data of the FR-PU04/PU04V deletes the previous data.
- The parameter settings of three inverters can be stored in areas 1 to 3.
- Read and write cannot be stopped during execution.
- If power is switched OFF, parameter data stored in the parameter unit remains unerased.



(2) Verifying the parameters





All the parameter settings stored in the FR-PU04/PU04V are verified with those which are stored in the inverter.



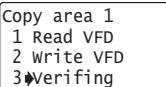
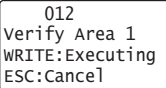

REMARKS

Verification cannot be performed between different inverter series.

1	Refer to <i>page 66</i> and copy the parameter settings of the verify source inverter to the FR-PU04/PU04V.
2	Connect the FR-PU04/PU04V to the inverter to be verified.
3	<p>Press .</p> <p>The help menu appears.</p> <div style="border: 1px solid black; padding: 5px; width: fit-content; margin-left: auto; margin-right: auto;"> <p>1  MONITOR 2 PU Oper 3 Pr.List 4 Pr.Clear </p> </div>
4	<p>Select the "multiple copies".</p> <p>Using /, move the cursor to "12 PRCpy set" and press .</p> <div style="border: 1px solid black; padding: 5px; width: fit-content; margin-left: auto; margin-right: auto;"> <p>9 S/w  10 Selectop 11 Option 12  PRCpy set</p> </div>

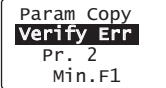
5	<p>Select the copy area.</p> <p>Point the cursor to the copy area that stores the parameter settings required verification, and press .</p>	<p>1  Copy area 1 2 Copy area 2 3 Copy area 3</p>
----------	--	--

6	<p>Select the "Verifying".</p> <p>Using /, point the cursor to "3 Verifying" to press .</p>	 <pre>Copy area 1 1 Read VFD 2 write VFD 3 Verifying</pre>
7	<p>Verification of the parameter settings is selected, and the confirmation screen for verification is displayed.</p>	 <pre>012 Verify Area 1 WRITE:Executing ESC:Cancel</pre>
8	<p>Press .</p> <p>Start verification of parameter settings stored in the FR-PU04/PU04V and parameter settings of the inverter.</p>	 <pre>Param Copy Verifying Please wait</pre>

9	<p>If an error is detected during verification, the corresponding <i>Pr.</i> is shown. Note that only "Verify Err" will be displayed if an incorrect value has been entered directly (f setting) or set in either <i>Pr. 173</i> or <i>Pr. 174</i>.</p>	 <pre>Param Copy Verify Err Pr. 2 Min.F1</pre>
10	<p>Press .</p> <p>When verification is stopped with verification error, press  to continue verification.</p>	
11	<p>Verification is complete.</p>	 <pre>Param Copy Verifying Completed</pre>

3.3 Other Precautions

3.3.1 Precautions for parameter unit operation

Note the following items when operating the parameter unit to prevent setting from being disabled or incorrect values from being entered.

- **Precautions for the digit count and decimal point of input value**

The maximum number of input digits is six including a decimal point. If you enter a value in excess of 6 digits, the most significant digit is ignored.

12345.6 → ■2345.6
(Input) ↑ Ignored

4 OPERATION

4.1 How to Select the Operation Mode

4.1.1 Switching from External operation mode [EXT] to PU operation mode [PU]

Confirmation

Make sure that the external input signal (STF, STR) is OFF.

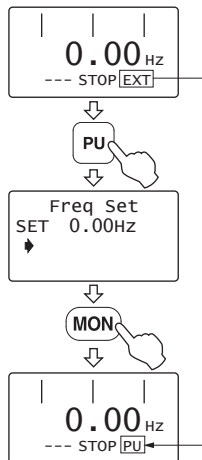

Pressing **PU** switches to the PU operation mode and changes the operation mode indication to [PU].

4.1.2 Switching from PU operation mode [PU] to External operation mode [EXT]

Confirmation

Make sure that the external input signal (STF, STR) is OFF and that the operation command indication is "- - -".

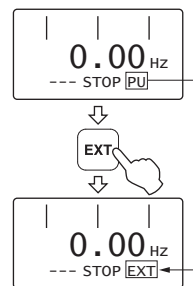



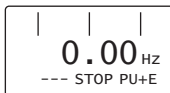

Pressing **EXT** switches to the External operation mode and changes the operation mode indication to [EXT].

4.1.3 Switching to the External / PU combined operation mode

Changing the *Pr. 79 Operation mode selection* setting to "3" or "4" switches to the External / PU combined operation mode. "PU+E" is displayed in the operation mode indication position.



The relationship between the running frequency and the start signal is as indicated in the following table.

<i>Pr. 79</i> Setting	Description	
	Running Frequency Setting	Start Signal
3	Parameter unit · Direct setting and  /  key setting External signal input · Multi-speed selection (<i>Pr. 4 to Pr. 6, Pr. 24 to Pr. 27</i>) · 4 to 20mADC across terminals 4-5	External signal input · Terminal STF · Terminal STR
4	External signal input · 0 to 5/10VDC across terminals 2-5 · 4 to 20mADC across terminals 4-5 · Multi-speed selection (<i>Pr. 4 to Pr. 6, Pr. 24 to Pr. 27</i>) · JOG frequency (<i>Pr. 15</i>)	Parameter unit ·  · 

REMARKS

If the operation mode cannot be switched properly, check the following:

- Make sure that the external input signal is OFF. If it is ON, the operation mode (STF or STR signal) cannot be switched properly.
- Confirm the *Pr. 79 Operation mode selection* setting.
(Refer to *page 71* and *the inverter instruction manual*)

4.2 How to Operate PU Operation

4.2.1 Normal operation

During motor operation, the speed can be changed by simply executing Step 2.

Step	Operation Procedure	Image
1	Switch power ON. Make sure that the monitor appears.	
2	Set the running frequency. Set the running frequency using direct setting or step setting. (Refer to page 20)	
3	Press FWD or REV . The motor starts running. The parameter unit automatically enters the monitoring mode and shows the output frequency.	

Step	Operation Procedure	Image
4	Press STOP RESET . The motor is decelerated to a stop.	

REMARKS

- When performing PU operation to run the motor, pressing the start key (**FWD** or **REV**) after setting the running frequency switches to monitor mode automatically.

4.2.2 PU Jog operation

Hold down **FWD** or **REV** to perform operation, and release it to stop.

Jog operation cannot be performed in the following cases:

- During motor operation
- The *Pr. 15 Jog frequency* is less than the *Pr. 13 Starting frequency*.

Example: To operate at the PU Jog running frequency of 8Hz

Step	Operation Procedure	Image
1	Switch to the PU operation mode. If the operation mode indication is not [PU], refer to <i>page 71</i> and switch to the PU operation mode.	
2	The frequency for Jog operation can be set with <i>Pr. 15 Jog frequency</i> and the acceleration/deceleration time with <i>Pr. 16 Jog acceleration/deceleration time</i> both in the parameter unit. (Refer to <i>page 23</i> for the parameter setting method.) <Initial value> · <i>Pr. 15</i> 5Hz · <i>Pr. 16</i> 0.5s	



Step	Operation Procedure	Image
3	Press PU , then SHIFT . The PU Jog operation mode is selected, and the PU Jog frequency setting screen appears on the display. To change the frequency, enter the value and press WRITE .	
4	Press FWD or REV . The display changes to the monitor screen. Hold down the key to perform operation and release it to stop.	
5	Press PU . The inverter exits from the Jog operation mode and returns to the ordinary PU operation mode.	

REMARKS

- The Jog operation mode may also be selected from **HELP**. (Refer to *page 50*)

4.3 Combined Operation (Operation Using External Input Signals and PU)

4.3.1 Entering the start signal from outside and setting the running frequency from the PU (Pr. 79 = 3)

The external frequency setting signals and  and  of the parameter unit are not accepted.

Stop with  is valid when Pr. 75 Reset selection/disconnected PU detection/PU stop selection = "14 to 17".

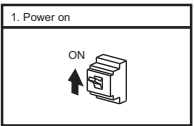
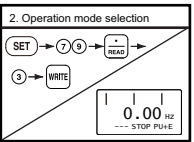
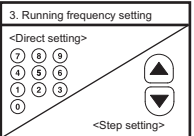
Step	Operation Procedure	Image
1	Switch the power ON.	
2	Set "3" in Pr. 79 Operation mode selection. The External/PU combined operation mode is selected and the operation mode indication on the display changes to "PU + E".	
3	Set the running frequency. Set the running frequency using direct setting or step setting. (Refer to page 20)	

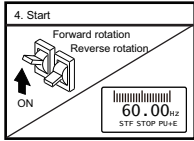
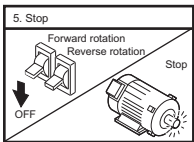
Step	Operation Procedure	Image
4	Set the start switch (STF or STR) to ON. The operation command indication changes to "STF" or "STR" and the operation status indication changes to the output (FWD or REV) indication. · If the forward and reverse rotation switches are both set to ON, the inverter will not start. Also, if these switches are both set to ON during operation, the motor is decelerated to a stop.	
5	Set the start switch (STF or STR) to OFF. The motor stops running.	

4.3.2 Entering the running frequency from outside and making start and stop from the PU (Pr. 79 = 4)

Step	Operation Procedure	Image
1	Switch the power ON.	<p>1. Power on</p> <p>ON</p>
2	Set "4" in Pr. 79 Operation mode selection. The External/PU combined operation mode is selected and the operation mode indication on the display changes to "PU + E".	<p>2. Operation mode selection</p> <p>0.00 Hz --- STOP PU+E</p>
3	Enter the external frequency command. Select the multi-speed signal or turn the frequency setting potentiometer.	<p>3. Running frequency</p> <p>High speed Middle speed Low speed</p> <p>ON</p> <p>or</p>

Step	Operation Procedure	Image
4	Press FWD or REV of the parameter unit. The motor starts running, and the state of the output frequency is shown on the display. ·The starting terminals (STF, STR) of the inverter are invalid. ·The inverter may also be started by pressing the PU FWD or REV and then inputting the frequency command.	<p>4. Start</p> <p>FWD (or) REV</p> <p>60.00 Hz STOP PU+E</p>
5	Press STOP RESET of the parameter unit. The motor is decelerated to a stop.	<p>5. Stop</p> <p>STOP RESET</p> <p>Stop</p>

4.3.3 Entering the start signal and multi-speed signal from outside and setting multiple speeds from the parameter unit

Step	Operation Procedure	Image
1	Switch the power ON.	
2	Select the multi-speed signal required for operation. Switch the RH, RM or RL signal ON.	
3	Set the start switch (STF or STR signal) to ON. The operation command indication changes to "STF" or "STR", the operation status indication changes to the output (FWD or REV) indication, and the motor starts running. · If the forward and reverse rotation switches are both set to ON, the inverter will not start. Also, if these switches are both set to ON during operation, the motor is decelerated to a stop.	

Step	Operation Procedure	Image
4	Change the multi-speed frequency during operation from the parameter unit. When high speed has been selected (RH signal ON), changing the <i>Pr: 4 Multi-speed setting (high speed)</i> value varies the speed. · The other multiple-speed settings not being used may also be changed during operation.	
5	Switch off the multi-speed signal (RH, RM or RL signal) and set the start switch (STF or STR signal) to OFF. The motor stops running.	

5 CHECK FIRST WHEN YOU HAVE A TROUBLE

5.1 Troubleshooting

If a fault occurs and the inverter fails to operate properly, locate the cause of the fault and take proper corrective action by referring to the troubleshooting below. If the corresponding information is not found in the table, the inverter has problem, or the component parts are damaged, contact your sales representative.

Status	Possible Causes	Check Point	Corrective Action
The LCD or backlight of the parameter unit does not light.	Connection fault of the parameter unit	Check that the parameter unit is connected properly. Or check that the PU cable is inserted far into the PU connector.	Check the connection of the parameter unit and the PU cable.
	The setting of <i>Pr. 991 PU contrast adjustment</i> is changed from the initial value.	Check the <i>Pr. 991</i> setting.	Return the <i>Pr. 991</i> setting to the initial value using the operation panel.
	The inverter is in the standby status.	The inverter is in the standby status.	Check whether the PU cable is disconnected.
Check whether the RES signal of the inverter is ON.			Turn OFF the RES signal of the inverter.
The "MITSUBISHI" display remains on and it will not accept operation.	During inverter reset	Check whether RES signal is ON	Turn OFF the RES signal.
	Connection fault of a cable or connector	Check that no cable damage nor connection fault of a connector is found.	Replacement of a cable Check for a connector connection

6 SPECIFICATIONS

6.1 Standard Specifications

Item	Specifications
	FR-PU04/PU04V
Surrounding air temperature	-10°C to +50°C (non-freezing) *1
Ambient humidity	90%RH or less (non-condensing)
Storage temperature	-20°C to +65°C *2
Ambience	Indoors (free from corrosive gas, flammable gas, oil mist, dust and dirt)
Altitude, vibration	Maximum 1000m above sea level for standard operation. 5.9m/s ² or less at 10 to 55Hz (directions of X, Y, Z axes)
Power supply	Power is supplied from the inverter.
Connection	Installed to the inverter or connected to the inverter by the cable.
Display	LCD (liquid crystal display, 16 characters 4 lines)
Data retention	Onboard EEPROM
Number of write times	Maximum 100,000 times

*1 At the low temperatures of less than about 0°C, the liquid crystal display (LCD) may be slower in operation.
At high temperatures, the LCD life may become shorter.

*2 Temperatures applicable for a short time, e.g. in transit.

CAUTION

- Do not expose the liquid crystal screen to direct sunlight.
- During transportation, avoid applying load to the liquid crystal display.

6.2 Outline Drawing and Panel Cutting Drawing

6.2.1 FR-PU04/PU04V outline dimension drawings

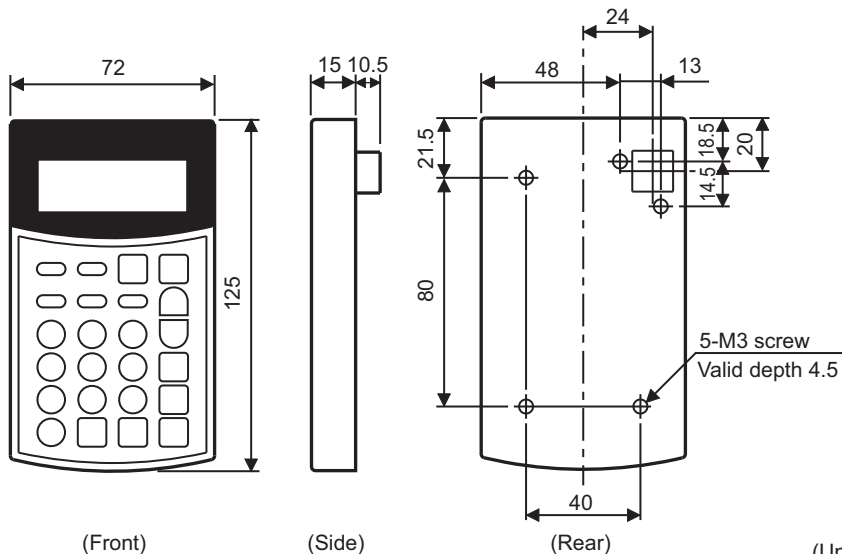

Appendix 1 Disposing of the equipment in the EU countries

- The symbol shown below, which is printed on the product for EU countries, means that electric and electronic equipment, at their end-of-life, should be disposed of separately from your household waste.
- Please, dispose of this equipment at your local community waste collection/recycling centre if it is to be disposed of in EU countries.
- In the European Union, there are separate collection systems for used electrical and electronic product.
- Please, help us to conserve the environment we live in.

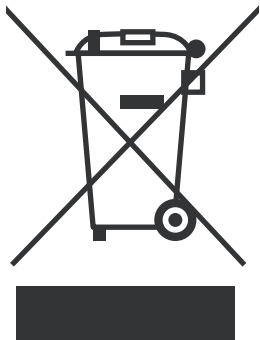

Note: This symbol is for EU countries only.

This symbol is according to the directive 2006/66/EC Article 20 Information for end-users, Article 21 Labelling, and Annex II.

MEMO

INVERTER

mitsubishi electric corporation

HEAD OFFICE: TOKYO BUILDING 2-7-3, MARUNOUCHI, CHIYODA-KU, TOKYO 100-8310, JAPAN

IB(NA)-0600637ENG-A(1604) MEE

Printed in Japan

Specifications subject to change without notice.